

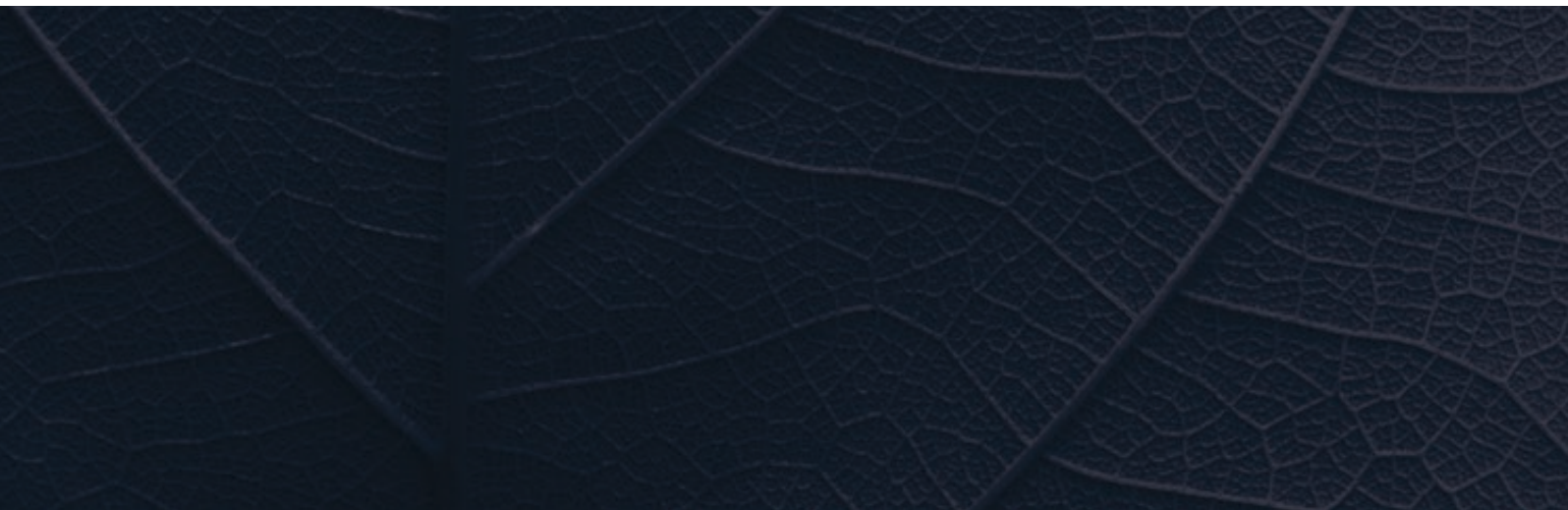

2022 CATALOG





2022: A TASTY AND FULL-BODIED SAP

After a 2021 sugar season considered disappointing by the majority of maple syrup producers and observers, the 2022 season is slowly taking on the air of spring as the maple trees grow and will provide a tasty and full-bodied sap.

If for some, this season is a promise of joy in the shack centered on small-scale production, for others, it is more of a business issue with its commercial objectives.

Whatever the case, what drives all our producers is the same passion for maple syrup production.

Your passion is also ours. You already know that. That's why we focus on meeting the challenges of your productivity, regardless of your personal goals or the size of your sugar bush. We focus our efforts on innovation because we have surrounded ourselves with people who are not just highly talented, but also curious and inventive.

LAPIERRE is a solid family business with a human touch. Its dominant gene is the research and development of automated processes aimed at reducing human intervention in the production process.

For example, our DATACER system continues its technological evolution with the improvement of its software and the addition of new peripherals. This season we are proud to roll out the Passerelle Dater to our partners, enabling them to connect all stations on the same local network. This feature provides more speed and control as well as greater installation flexibility.

The pandemic has caused our teams to redouble their efforts in 2021 to address the challenges of workforce availability and the fluidity of our supplies. Our people have been resourceful and have been able to meet a higher demand than in previous years, without compromising on quality or service. Congratulations and thank you!

Good news in Quebec! The Québec Maple Syrup Producers (QMSP) is increasing the tapping quota by 7 million. This is a historic decision that will not only benefit the industry and equipment manufacturers, but also many new and talented producers.

While we operate in a competitive environment, we believe in partnering with organizations that are aligned with values that promote the overall growth of our industry. This is why we support the University of Sherbrooke's industrial research chair in maple syrup technology (CRITA); the Centre ACER for maple research, development and technology transfer; the University of Vermont's Proctor Maple Research Center; the International Maple Syrup Institute (IMSI); the Créneau d'Excellence Acéricole; and all the activities of Érable & Chalumeaux.

May your 2022 sugars live up to all your expectations!

We look forward to seeing you soon,

Chantal, Anick, Carl et Donald Lapierre



SAP GATHERING

- Tubing..... 6
- Fittings..... 8
- Accessories and miscellaneous 16

DATA CER

- Sugarbush automation 28

EXTRACTORS

- Extractors and accessories 33
- Transfer tanks and manifolds 45
- Water pumps 46

VACUUM PUMPS

- Pumps: Busch, Sihi 49
- Accessories 58

WATER STORAGE

- Stainless tanks..... 60
- Accessories 66

CONCENTRATION

- Reverse osmosis..... 67
- Accessories 75

EVAPORATION

- Evaporators..... 82
- Accessories and miscellaneous 96

TRANSFORMATION

- Filtration and conditioning..... 112
- Packaging 115
- Accessories and miscellaneous 122

DEALERS

- Dealers 124



WELL THOUGHT-OUT SOLUTIONS FOR YOUR COLLECTION SYSTEM!

MAPLEFLEX is a flexible solution inspired by a selection of products designed to optimize the management of your sap gathering system and facilitate installation, tapping and maintenance operations.

INSPIRED NEW PRODUCTS!

FLEXClip™ PATENT PENDING

SEE PAGE 15

OPTIMAL VACUUM, QUICK & EASY INSTALLATION

With utmost efficiency and exemplary design, the **FLEXClip** self adjusts and perfectly matches the main-line for optimal grip and vacuum.

The gasket, made of self-adhering food grade material, ensures an impeccable maintenance of the assembly. The inner surface of the **FLEXClip** has molded-in diamond-tipped anchors. These retaining points penetrate the surface of the pipe, consolidating the whole assembly to the main-line.



MAX15

SEE PAGE 7

TUBING WITH EXCEPTIONAL PROPERTIES

The brand new 5/16 semi-rigid is made from the best food grade resins to ensure excellent waterproofing, mnemonic elasticity (shape memory) and maximum transparency. The **MAX15** is the result of proven expertise as a user and extruder of maple syrup tubing.

The orientation, altitude and topography of your maple sugar bush will certainly have an influence on the performance of your collection system. The choice of a specific colour will also affect freezing and thawing cycles. Whether for a new installation, a new area or tubing replacement, the **MAX15** is the choice of maple syrup producers.



REFLEX SPOUT FLEXIBLE NYLON, MEDIUM GREY

EXCELLENT BEHAVIOR IN FREEZE-THAW CYCLES

MAPLEFLEX offers a new hybrid sap spout, the best combination. Rethought and redesigned, it is the result of a successful collaboration between Lapierre and maple syrup experts. Made of flexible resin, the hybrid spout retains its original shape memory, which ensures optimal seal. The ideal compromise between thawing and freshness!



SEE PAGE 8



GET THE BEST
GATHERING SYSTEM
AVAILABLE TODAY

Your gathering system is the backbone of your sugaring operation's profitability. We offer several categories of 5/16" and 3/16" tubing. Ask your representative today.

Lapierre Equipment is more than just a distributor. We manufacture our MapleFlex® 5/16" tubing and mainlines in our proprietary extrusion plant, **using only the best raw materials and the best U.V. protection** available. We produce and deliver with the highest quality standards in the business.

MAPLEFLEX® HIGH DENSITY MAINLINE

MapleFlex introduces you to a brand new high density (HD) mainline produced with the same features and production standards. Lighter and more affordable, the MapleFlex HD mainline provides the same vacuum resistance for the same diameter while being thinner.

HDPE food grade, more affordable, UV protection, aerial and underground installation, 10 year warranty.

MAPLEFLEX® HD MAINLINE (125 PSI)			CODE
MapleFlex HD 3/4"	Black	500 feet	TU007-120500H1
MapleFlex HD 3/4"	Black	1000 feet	TU007-121000H1
MapleFlex HD 3/4"	Black	2500 feet	TU007-122500H1
MapleFlex HD 1"	Black	500 feet	TU007-160500H1
MapleFlex HD 1"	Black	1500 feet	TU007-161500H1
MapleFlex HD 1 1/4"	Black	500 feet	TU007-200500H1
MapleFlex HD 1 1/4"	Black	1000 feet	TU007-201000H1
MapleFlex HD 1 1/2"	Black	500 feet	TU007-240500H1

SEMI-RIGID 3/16" MAPLEFLEX® TUBING (500')			CODE
MapleFlex® ULTRA15	15 years warranty	Light blue	TU386-000000XX
MapleFlex® ULTRA15	15 years warranty	Vision green	TU386-010000XX
MapleFlex® SUPER10	10 years warranty	Light blue	TU389-000000XX
MapleFlex® SUPER10	10 years warranty	Vision green	TU389-010000XX

Tools and accessories for 3/16" tubing are also available.

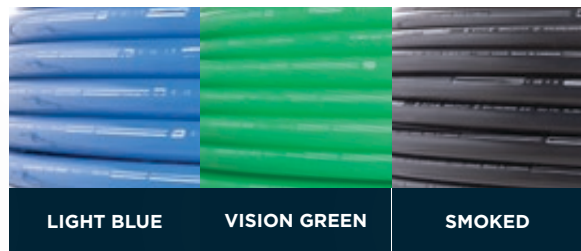

SEMI-RIGID 5/16" MAPLEFLEX® TUBING (500')	CODE
MapleFlex® ULTRA15 15 years warranty Light blue	TU086-000000XX
MapleFlex® ULTRA15 15 years warranty Vision green	TU086-010000XX
MapleFlex® ULTRA15 15 years warranty Smoked	TU086-040000XX
MapleFlex® MAX15 15 years warranty Light blue	TU084-000000XX
MapleFlex® MAX15 15 years warranty Vision green	TU084-010000XX
MapleFlex® MAX15 15 years warranty Smoked	TU084-040000XX
MapleFlex® MAX15 15 years warranty Dark blue	TU084-050000XX
MapleFlex® SUPER10 10 years warranty Light blue	TU089-000000XX
MapleFlex® SUPER10 10 years warranty Vision green	TU089-010000XX
MapleFlex® SUPER10 10 years warranty Smoked	TU089-040000XX

RIGID 5/16" MAPLEFLEX® TUBING (500')	CODE
MapleFlex® RIGID10 10 years warranty Light blue	TU092-000000XX
MapleFlex® RIGID10 10 years warranty Vision green	TU092-010000XX

Our MAPLEFLEX® mainlines are made to work at the highest vacuum levels. Above 28 in/Hg. high vacuum allows for higher sap yields.

Pre-cut or assembled drop lines
 Standard lengths of 30", 36" and 40" with tubing, spout and tee of your choice.
 For any other lengths, a minimum quantity will be required.

BLUE MAPLEFLEX® MAINLINE (100 PSI)	CODE
3/4" 500', 2500'	TU002-12****H1
1" 500', 1000', 2000'	TU002-16****H1
1 1/4" 500', 1200'	TU002-20****H1
1 1/2" 500', 1200'	TU002-24****H1
2" 500'	TU002-32****H1

VISION GREEN MAPLEFLEX® MAINLINE (100 PSI)	CODE
3/4" 500', 2500'	TU014-12****H1
1" 500', 1000', 2000'	TU014-16****H1
1 1/4" 500', 1200'	TU014-20****H1
1 1/2" 500', 1200'	TU014-24****H1

SMOKED MAPLEFLEX® MAINLINE (100 PSI)	CODE
1" 500', 1000', 2000'	TU013-16****H1
1 1/4" 500', 1200'	TU013-20****H1
1 1/2" 500', 1200'	TU013-24****H1

BLACK MAPLEFLEX® MAINLINE (100 PSI)	CODE
1/2" 100', 400'	TU001-08****H1
3/4" 500', 2500'	TU001-12****H1
1" 500', 1000', 2000'	TU001-16****H1
1 1/4" 500', 1200'	TU001-20****H1
1 1/2" 500', 1200'	TU001-24****H1
2" 200', 500'	TU001-32****H1

To order mainline by specific length, replace ** by feet number.**
 For 200', 400' and 500', add a 0 before the length
 ex.: TU007-12****H1 = TU007-12**0500**H1
 For 1000', 1200', 2000' and 2500' just replace the *
 ex.: TU007-12****H1 = TU007-12**2500**H1

Spout

IMPROVED MODEL



NEW DESIGN
ENLARGED HEAD DESIGN
MAKES TAPPING EASIER

REFLEX



ELBOW STYLE SPOUT (2 BARBS)

TAP DIAMETER	TUBING DIAMETER	MATERIAL	COLOR	WALL	ZML	CODE
1/4"	5/16"	Nylon	Black	Std	√	TU282-105504N4B
1/4"	5/16"	Nylon	Dark blue	Std	√	TU282-105504N5B
1/4"	5/16"	Soft nylon	Black	Std	√	TU282-105504Y4B
1/4"	5/16"	Soft nylon	Grey	Std	√	TU282-105504Y8B
5/16"	5/16"	Nylon	White	Std	√	TU282-106505N1B
5/16"	5/16"	Soft nylon	White	Std	√	TU282-106505Y1B
5/16"	5/16"	Soft nylon	Black	Std	√	TU282-106505Y4B
5/16"	5/16"	Soft nylon	Grey	Std	√	TU282-106505Y8B

ELBOW STYLE SPOUT (1 BARB)	TAP DIAMETER	TUBING DIAMETER	MATERIAL	COLOR	WALL	ZML	CODE
Seasonal	1/4"	3/16"	Polycarbonate	Clear	Thin	√	TU279-105604J9B
	1/4"	3/16"	Nylon	Black	Thin	√	TU279-105604N4B
	5/16"	3/16"	Nylon	Black	Thin	√	TU279-106105N4B
	5/16"	3/16"	Polycarbonate	Clear	Thin	√	TU279-106105J9B
Seasonal	5/16"	5/16"	Polycarbonate	Clear	Thin	√	TU279-106505J9B



SEASONAL SPOUT	TAP DIAMETER	TUBING DIAMETER	MATERIAL	COLOR	WALL	ZML	CODE
For stubby spout holder	1/4"	5/16"	Polycarbonate	Clear	Std	√	TU250-208004J9B
For stubby spout holder	5/16"	5/16"	Polycarbonate	Clear	Std	√	TU250-209005J9B



Standard seasonal spout



Long seasonal spout

STRAIGHT SPOUT	TAP DIAMETER	TUBING DIAMETER	MATERIAL	COLOR	WALL	ZML	CODE
Standard seasonal spout with retaining ring	1/4"	5/16"	Polycarbonate	Clear	Std	√	TU047-108034J9B
Long seasonal spout with retaining ring	1/4"	5/16"	Polycarbonate	Clear	Std	√	TU047-108044J9B
Standard seasonal spout with retaining ring	5/16"	5/16"	Polycarbonate	Clear	Std	√	TU047-109035J9B
Long seasonal spout with retaining ring	5/16"	5/16"	Polycarbonate	Clear	Std	√	TU047-109045J9B

BEST SELLER



Short joint spout



LTS-USA spout

Designed by sugarmakers.
A minimal angle to strongly seal the tap hole.

ELBOW SPOUT SHORT JOINT	TAP DIAMETER	TUBING DIAMETER	MATERIAL	COLOR	WALL	ZML	CODE
Elbow, short joint	5/16"	5/16"	Polycarbonate	Clear	Thin	√	TU281-106505J9B
LTS-USA 1,1570°	5/16"	5/16"	Polycarbonate	Clear	Std	√	TU300-106705J9B
LTS-USA 1,1570°	5/16"	5/16"	Polycarbonate	Clear	Thin	√	TU301-106705J9B



Retaining hooks

DESCRIPTION	TAP DIAMETER	TUBING DIAMETER	MATERIAL	COLOR	WALL	ZML	CODE
Y spout 130°	1/4"	5/16"	Polycarbonate	Clear	Thin	✓	TU285-103004J9B
Y spout 130°	1/4"	5/16"	Nylon	Light blue	Thin	✓	TU285-103004N7B
Y spout 130°	5/16"	5/16"	Polycarbonate	Clear	Thin	✓	TU285-104005J9B
Y spout 130°	5/16"	5/16"	Nylon	Light blue	Thin	✓	TU285-104005N7B



1 ST GENERATION SPOUT	TAP DIAMETER	TUBING DIAMETER	MATERIAL	COLOR	WALL	CODE
Seasonal elbow style spout	1/4"	5/16"	Polycarbonate	Clear	Std	TU048-000004J9B
Seasonal elbow style spout	5/16"	5/16"	Polycarbonate	Clear	Std	TU048-000005J9B



ORIGINAL SPOUT	TAP DIAMETER	TUBING DIAMETER	MATERIAL	COLOR	WALL	CODE
A - Elbow style spout	5/16"	5/16"	Nylon	Black	Std	TU051-000005J4B
B - Elbow style spout with rib	5/16"	5/16"	Nylon	Black	Std	TU050-000005J4B
C - Short spout	7/16"	5/16"	Nylon	Black	Std	TU055-000007J4B

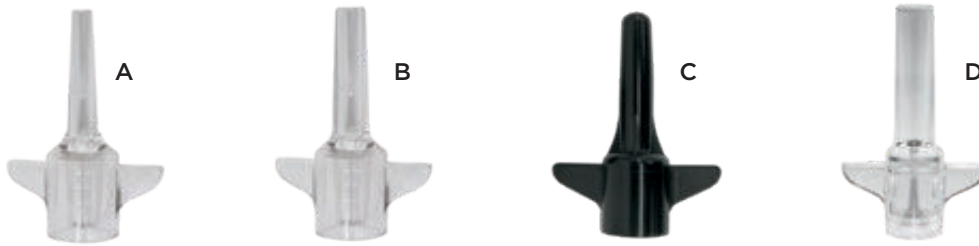

DESCRIPTION	TAP DIAMETER	ADAPTOR DIAMETER	MATERIAL	COLOR	WALL	CODE
A - Spout adaptor	1/4"	7/16"	Polycarbonate	Clear	Std	TU054-000416J9B
B - Spout adaptor	5/16"	7/16"	Polycarbonate	Clear	Std	TU054-000516J9B
B - Spout adaptor	5/16"	7/16"	Polycarbonate	Clear	Thin	TU254-000516J9B
C - Spout adaptor	5/16"	7/16"	Nylon	Black	Std	TU054-000516J4B
D - Spout adaptor	5/16"	5/16" and 19/64"	Polycarbonate	Clear	Thin	TU256-000516J9B

Stericap



STERICAP AND HOOK	CODE
Blue	TU298-146005L7B

Stericap, is a reusable 5 ml. isopropyl alcohol tight sealed container.

No mould parting line at the spout tip or tubing connection to completely eliminate micro-leaks, will help reaching maximum vacuum levels and higher yields.



STARS	CODE
Star 3 way	TU020-000003J4
Star 4 way	TU020-000004J4
Star 6 way	TU020-000006J4

Fitting and adaptor



ORIGINAL FITTING (2 BARBS)	TUBING DIAMETER	MATERIAL	COLOR	ZML	CODE
A - Connector with hook	3/16"	Nylon	Black	✓	TU134-020003J4
A - Connector with hook	5/16"	Nylon	Black	✓	TU134-000002J4
B - Reducer hook connector	3/16" and 5/16"	Nylon	Black	✓	TU334-020305N4
C - Y	5/16"	Nylon	Black	-	TU026-000000J4
D - End of line eyelet	5/16"	Nylon	Black	-	TU027-000000J4
E - Rubber plug	5/16"	Nylon	Blue	-	TU028-000000XX
F - Slide fitting	5/16"	Nylon	Black	-	TU030-000000J4
F - Slide fitting	3/16"	Nylon	Black	-	TU067-150103N4
G - End of line tie for slide fitting	5/16"	Nylon	Black	-	TU031-000000J4
H - End of line hook for slide fitting	5/16"	Nylon	Black	-	TU032-000000J4
I - Connector	5/16"	Nylon	Black	✓	TU133-000002N4
J - Eyelet drop-line plug (seasonal spout)	5/16"	Nylon	Black	-	TU114-000000J4
K - End of line drop-line hook (3 ST)	3/16"	Nylon	Black	✓	TU131-317002N4
L - End of line drop-line hook (3 ST)	5/16"	Nylon	Black	✓	TU330-000002N4
L - End of line drop-line hook	5/16"	Nylon	Black	✓	TU331-010205N4
M - End of line drop-line hook	5/16"	Nylon	Red	✓	TU132-142500J03



innovateur de nature

ONLINE STORE

MAPLE EXPERT

MAPLE SYRUP PRODUCTION AT YOUR FINGERTIPS!

LAPIERRE and its network of experts and advisors offer you their brand-new, high-tech online ordering tool. Order at your fingertips, from the comfort of your home, plumbing parts, tools, accessories, tubing, mainlines, spouts, fittings, clothing, and much more in just a few clicks.

It's beautiful, brand-new, and totally techy! And although your MAPLE EXPERT online store is already well-stocked, continuous updates are adding brand-new products.

Do you want to purchase a piece of equipment? It's simple to request an online quote to learn all the details about our evaporators, concentrators, extractors, or any other product offered by **LAPIERRE**.

It's simple. It's fast. And it's connected!

Access your online store at
www.maple.expert



Tee-plug



ORIGINAL TEE-PLUG (2 BARBS)	TUBING DIAMETER	MATERIAL	COLOR	ZML	CODE
A - Universal tee-plug 3 stages	5/16"	Nylon	Black	✓	TU240-020003J4
A - Universal tee-plug 3 stages	3/16"	Nylon	Black	✓	TU040-030200N4
B - Red tee-plug, 3 stages (left side plug)	5/16"	Nylon	Red	-	TU042-000003J03
C - Tee-plug with cap-plug and drop-line plug	5/16"	Nylon	Black	-	TU045-000504J4
D - Tee-plug with elongated cap	3/16"	Nylon	Black	✓	TU341-326002N4
D - Tee-plug with elongated cap	5/16"	Nylon	Black	✓	TU241-927002J4
E - Tee-plug with elongated cap and hook	3/16"	Nylon	Black	✓	TU342-327002N4
F - Tee-plug with cap-plug	5/16"	Nylon	Black	✓	TU241-000002J4

Fixed head and swivel head fittings black nylon



A - B



C

DESCRIPTION	DIAMETER	DRILL BIT SIZE	ZML	CODE
A - Saddle manifold with fixed head (fits on: 3/4", 1", 1 1/4", 1 1/2", 2")	3/16"	3/8"	-	TU122-060301J4
	3/16"	31/64"	-	TU122-310301J4
	5/16"	3/8"	✓	TU322-060201J4
	5/16"	31/64"	✓	TU322-310201J4
B - Saddle manifold with swivel head (fits on: 3/4", 1", 1 1/4", 1 1/2", 2")	5/16"	31/64" w/o clips	-	TU021-000001J4
C - Saddle manifold with tie-wrap (fits on: 3/4", 1", 1 1/4")	5/16"	31/64"	✓	TU323-310201J4
Tie-wrap (50 bag)				TU036-000000J4



FLEXClip™

PATENT PENDING

With utmost efficiency and exemplary design, the **FLEXClip** self adjusts and perfectly matches the main-line for optimal grip and vacuum.

The gasket, made of self-adhering food grade material, ensures an impeccable maintenance of the assembly. The inner surface of the **FLEXClip** has molded-in diamond-tipped anchors. These retaining points penetrate the surface of the pipe, consolidating the whole assembly to the main-line.

An innovative product, with unique design and features, making it the easiest and quickest fitting to install.

Developed in conjunction with ZML technology (ZERO MICRO LEAK)



NEW

QUICK AND EASY INSTALLATION PROCEDURE

Equipped with a wire hook, the FlexClip is guided by the support wire to perfectly position itself on the main-line.

- Insert the anchor on the wire, then move sideways by 1/4 of a turn, the FLEXClip aligns perfectly to position itself on the main-line and place the inlet of the fitting at an ideal angle.
- The pre-installed gasket sits and self-aligns on the pipe.
- A pre-molded seat allows the insertion of a stainless steel screw (hexagonal head 1/4").
- A built-in receptacle acts as a nut but also as a depth guide and screw tip protector.
- With a 7/32 drill bit, drill the main-line through the inlet of the FLEXClip.
- Slide the lateral line (5/16") on the inlet of the FLEXClip.
- After a few seconds, you are done, continue with the next one!

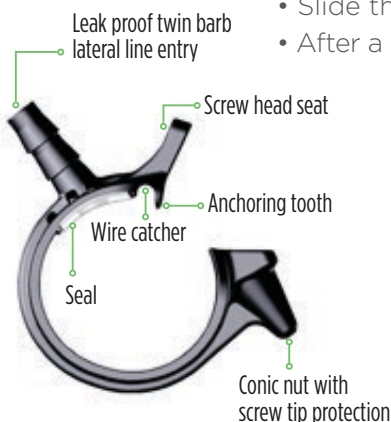
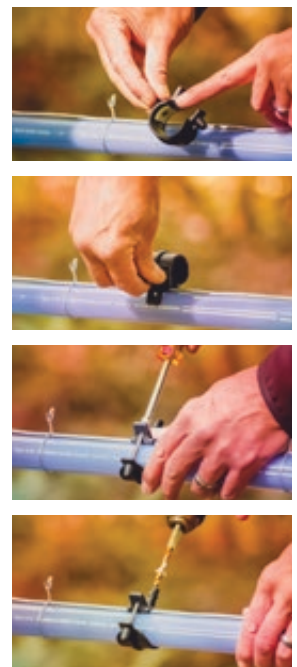

FLEXCLIP MANIFOLD - NYLON BLACK ZML 5/16"	CODE
Flexclip 3/4"	TU326-073212N4
Flexclip 1"	TU326-073216N4
Flexclip 1 1/4"	TU326-073220N4
DRILL BIT FOR FLEXCLIP	CODE
Drill bit 7/32"	TU437-000732XX



A - * Lid not included



B - * Lid not included



C



D



E



F



G



H



I



J



K



L

TRADITIONAL SAP GATHERING	CODE
A - 2 gallons green bucket	DV091-000002VE
B - 3 gallons green bucket	DV091-000003VE
Lid for 2 gallons green bucket	DV091-010002VE
Lid for 3 gallons green bucket	DV091-010003VE
C - 5/16" clear blue plastic bucket spout	TU059-000005J7

D - MAINLINE TENSION GRIPS	CODE
1/2"	TU490-000008XX
3/4"	TU490-000012XX
1"	TU490-000016XX
1 1/4"	TU490-000020XX
1 1/2"	TU490-000024XX
2"	TU490-000032XX

ACCESSORIES	CODE
E - Splices (2) for wirw 9 GA	TU061-000000XX
E - Splices (2) for wirw 12.5 GA	TU061-000002XX
F - Gripple	TU060-000000XX
F - Gripple (medium)	TU060-000002XX
G - Gripple tension tool	TU433-000000XX
H - Manual twister	TU450-000000XX
I - Automatic twister	TU435-000000XX
J - Plastic protector for wooden post	TU600-002000N4

Self-fusing silicone to repair air and water leakage, without any tools needed.

K - SELF-FUSING SILICONE TAPE		CODE
Blue	Roll 1" x 10'	DV840-016003BU
Yellow	Roll 1" x 10'	DV840-016003JA
Red	Roll 1" x 10'	DV840-016003RG
Blue	Roll 1,5" x 32'	DV840-024010BU
Yellow	Roll 1,5" x 32'	DV840-024010JA
Red	Roll 1,5" x 32'	DV840-024010RG

L - STARTER KIT	CODE
5 taps	DV895-000005KT
10 taps	DV895-000010KT
20 taps	DV895-000020KT
40 taps	DV895-000040KT



WIRE TIES 1000/BUNDLE (16 GA)		CODE
5"	3/4" tubing	TU073-100005G1
6"	1" tubing	TU073-100006G1
7"	1 1/4" tubing	TU073-100007G1
8"	1 1/2" tubing	TU073-100008G1
10"	2" tubing	TU073-100010G1
12"		TU073-100012G1

WIRE TIES 2500/BUNDLE (18 GA) AWT		CODE
5"	3/4" tubing	TU074-250005G1
6"	1" tubing	TU074-250006G1
7"	1 1/4" tubing	TU074-250007G1
8"	1 1/2" tubing	TU074-250008G1
10"	2" tubing	TU074-250010G1
12"		TU074-250012G1
14"	3" tubing	TU074-250014G1

WIRE TIES 2500/BUNDLE (18 GA)		CODE
5"	3/4" tubing	TU070-000005G1
6"	1" tubing	TU070-000006G1
7"	1 1/4" tubing	TU070-000007G1
8"	1 1/2" tubing	TU070-000008G1
10"	2" tubing	TU070-000010G1
12"		TU070-000012G1
14"	3" tubing	TU070-000014G1

WIRE TIES 1000/BUNDLE (18 GA)		CODE
5"	3/4" tubing	TU074-100005G1
6"	1" tubing	TU074-100006G1
7"	1 1/4" tubing	TU074-100007G1
8"	1 1/2" tubing	TU074-100008G1
10"	2" tubing	TU074-100010G1
12"		TU074-100012G1
14"	3" tubing	TU074-100014G1

GALVANIZED WIRE (50 LB)		CODE
#9 high carbon		TU075-000009G2
#9		TU075-000009G1
#12		TU075-000012G1
#14		TU075-000014G1

Galvanized wire 50 lb: #9 high carbon and #9 = between 950 and 1000 feet.

GALVANIZED WIRE (100 LB)		CODE
#9 high carbon		TU075-010009G2

HIGH TENSILE WIRE 12,5 GA		CODE
210 PSI (coil / 2000')		ETBRO012HD
210 PSI (coil / 4000')		ETBRO012H
200 PSI (coil / 4000')		TU875-200012XX



Wire tightner ratchet



Wire tightner ratchet handle

WIRE TIGHTNER RATCHET		CODE
SS ratchet		ETMRAT01
Wire tightner ratchet handle		ETMRAT02
Aluminium ratchet		ETMRAT04



LINEVIPER INSTALLATION MULTI-TOOLS		CODE
5/16"		TU412-000005XX
3/16"		TU412-000003XX

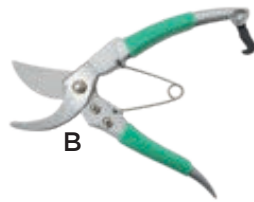

PRUNER	CODE
A - Pruner "Garant"	TU448-000000XX
B - 8" pruner	TU448-000002VE
C - Anvil pruner "Garant"	TU448-000001XX

CUTTER	CODE
D - Mainline cutter 2"	TU452-000032XX

MAINLINE LEVEL	CODE
E - Hand level Abney Sokkia 5" with percent & degree	TU451-000001XX
F - Hand level Sokkia 1x, 6"	TU451-000005XX

LAPIERRE APRONS	CODE
G - Orange Lapierre installation apron (10 pockets)	TU478-000001LA

MARKING SPRAY PAINT	CODE
H - (Blue)	DV547-000002XX
H - (Orange)	DV547-000011XX

UNIVERSAL	CODE
I - universal chainsaw mount	MC501-000001XX

J - LAPIERRE PNEUMATIC DROP LINE TOOL	CODE
Need a 3 HP compressor minimum (not included)	TU526-000001XX
3/16" tubing clamping block (steel)	TU526-011875XX
5/16" tubing clamping block (steel)	TU526-013125XX



Many snowshoes models are available. Ask your Lapierre representative for details.

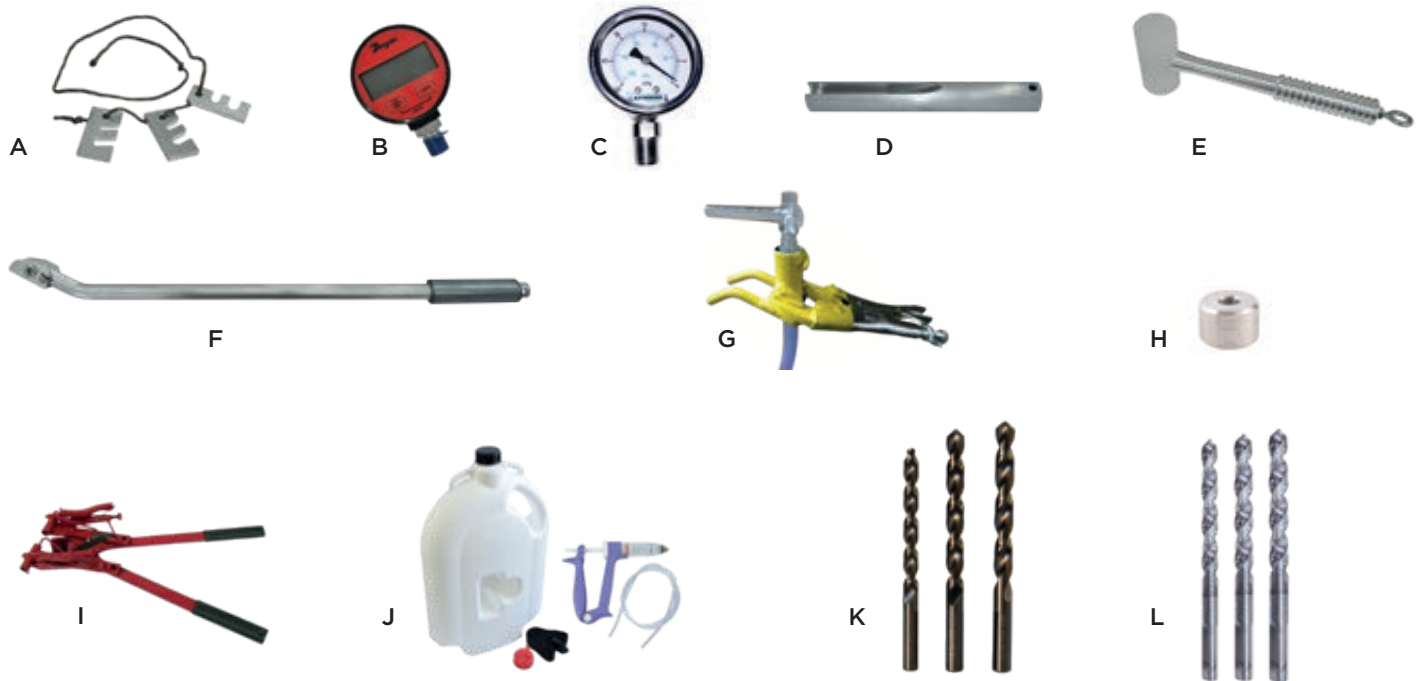

MISCELLANEOUS TOOLS	CODE
A - 3/16" and 5/16" tension hooks	TU115-000305XX
B - Manometer digital dwyer -30-0 2 1/2" 1/4" bottom connect	DV205-403040DI
C - Vacuum gauge -30-0 KPA 2" SS connection 1/4"	DV205-403032S6L
Vacuum gauge -30-0 KPA 2" Brass, 1/4"	DV205-403032SPL
Vacuum gauge -30-0 KPA 2 1/2" SS connection 1/4"	DV205-403040S6L
Vacuum gauge -30-0 KPA 2 1/2" Brass, 1/4"	DV205-403040SPL
Vacuum gauge -30-0 KPA 4" SS connection 1/4"	DV205-403064S6L
Vacuum gauge -30-0 KPA 4" Brass, 1/4"	DV205-403064SPL
D - 7-3/4" driver for seasonal spout*	TU420-070001A1
E - Tapping hammer*	TU440-000000XX
F - Spout remover 5/16" (24") for seasonal spout*	TU443-240005LA
F - Spout remover 5/16" (36") for seasonal spout*	TU443-360005LA
G - Elbow shape seasonal spouts installation pliers*	TU540-000000XX
H - Stopper for drill bit 19/64"	TU465-000019XX
H - Stopper for drill bit 5/16"	TU465-000005XX

TUBING INSTALLATION TOOL	CODE
I - Chamberland	TU427-000000XX

CLEANING	CODE
J - Complete cleaning kit for tubing	TU416-000008LX
Tap hole sprayer 1 litre	TU417-011024XX

K - LAPIERRE DRILL BITS FOR FROZEN AND NON-FROZEN WOOD	CODE
1/4"	TU437-000004XX
5/16"	TU437-000005XX
7/16"	TU437-000007XX
19/64"	TU437-000019XX

L - BOLDUC DRILL BITS FOR FROZEN AND NON-FROZEN WOOD	CODE
1/4"	TU437-000004BX
5/16"	TU437-000005BX
7/16"	TU437-000007BX
19/64"	TU437-000019BX

*LAPIERRE EQUIPMENT EXCLUSIVE TOOLS.



PRUNO
 OUTILS ACÉRIQUES D'ORIGINE
 GENUINE MAPLE SUGARING TOOLS

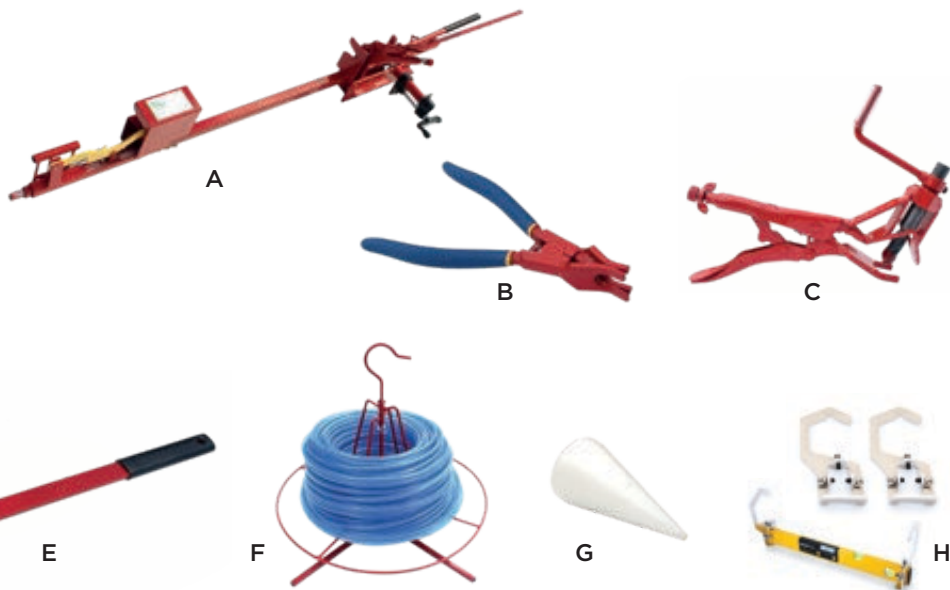

A - PRUNO RAPIDO-DROP WITH TUBING CUTTER	CODE
Rapido-drop, auto tubing cutter 3/16", 24" to 40"	TU525-7170001XX
Rapido-drop, auto tubing cutter 5/16", 24" to 40"	TU525-717000XX
Rapido-drop, auto tubing cutter 3/16", 28" to 48"	TU525-7170031XX
Rapido-drop, auto tubing cutter 5/16", 28" to 48"	TU525-717003XX

B - PRUNO SPOUT REDUCER EXTRACTOR	CODE
7/16"	TU444-000000XX
5/16"	TU444-000005XX

C - PRUNO HOLE PUNCH	CODE
5/16" (Yellow)	TU425-000005XX
3/8" (Black)	TU425-000006XX
7/16" (Blue)	TU425-000007XX
15/32" (Green)	TU425-000015XX
31/64" (Red)	TU425-000031XX

D - PRUNO WIRE PULLER	CODE
Wire tension grip 9"	TU436-071576XX
Wire tension grip 11"	TU436-071571XX

E - PRUNO SPOUT REMOVER	CODE
Spout remover light 15" for 5/16" & 7/16"	TU443-190507PL

F - PRUNO SPOOLERS	CODE
Pruno tubing reel without base	TU446-000000XX
Pruno base for tubing reel	TU447-000001XX
Vertical reel to be suspended	TU453-000000XX
Pruno horizontal wire spooler	TU575-000000XX

PRUNO MISCELLANEOUS TOOLS	CODE
G - Pruno threaded cone 1/4"	TU456-000005XX
Holder for right-hand drill	TU478-071936XX
H - Set hook holder line level for mainline 3/4" to 3" to 3"	TU551-071902XX
Spring for compact insert tool	TU439-000000XX

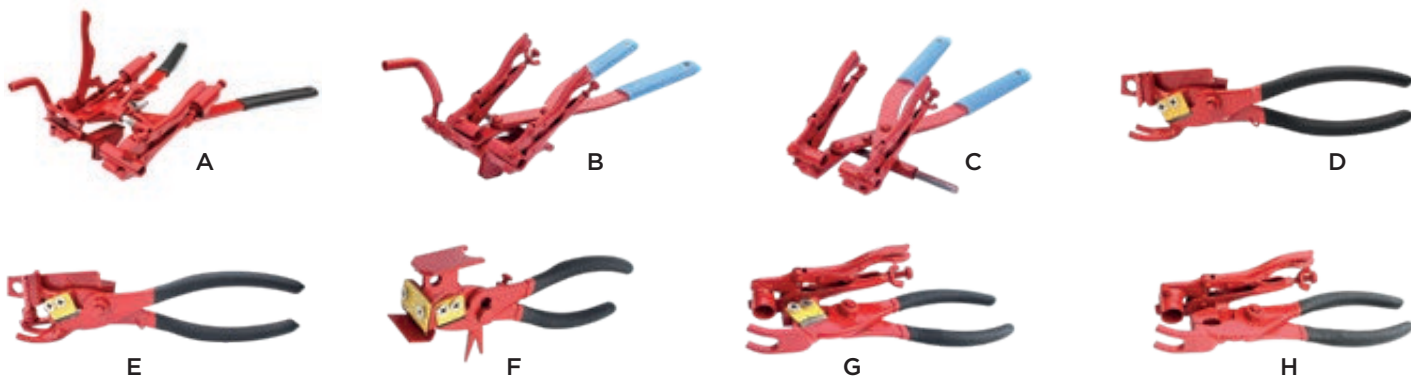

PRUNO TUBING INSTALLATION TOOL	CODE
A - 5/16" Pruno tubing installation auto-tension	TU428-000000XX
B - Pruno light installation tool with 3/16" jaw and cutter	TU528-711081XX
C - Pruno light installation tool with 3/16" jaw	TU528-711091XX
Plier - tubing installation "pruno" red with cutter w/o flaring tool	TU428-071106XX
Pruno installation plier, automatic calibratable pressure for 5/16" tubing. (without cutter or flaring device)	TU528-071112XX
Plier - installation Pruno light econo with out cutter and flaring tool	TU528-071109XX

PRUNO REPAIR TOOL	CODE
D - Pruno insertion tool with lateral cutter	TU429-000000XX
E - Pruno tubing installation tool lateral cutter and flaring tool	TU430-000000XX
F - Pruno tubing cutter 5 functions	TU432-000000XX
Pruno plier - stripping classic 5/16"	TU432-071206XX
G - Pruno compact insert tool with vise-grip and cutter	TU539-071065XX
H - Pruno compact insert tool with vise-grip without cutter	TU539-071060XX
Pruno insertion plier with lateral cutter for angle spouts (30° to 115°)	TU429-071067XX
Pruno insertion plier with 3/16" jaws, without cutter or flaring device	TU429-710506XX
Plier - flow-stopper, long nose and automatic tensioning	TU411-071919XX
Plier - flow-stopper, adjustment screw	TU411-071921XX



I - PRUNO MAINLINE INSTALLATION TOOLS	CODE
Pruno mainline installation tool 3/4" and 1"	TU445-001216XX
Pruno mainline installation tool 1" and 1 1/4"	TU445-001620XX
Pruno mainline installation tool 1 1/4" and 1 1/2"	TU445-002024XX
Pruno mainline installation tool 1 1/2" and 2"	TU445-002432XX
Pruno mainline installation tool 3/4" to 1 1/2" (kit)	TU445-001224XX

J - MAINLINE WIRING HOOK FOR ALIGN MAINLINE	CODE
0 to 1 1/4" stainless steel	TU555-071927XX
0 to 1 1/4" aluminium	TU555-071926XX
0 to 2" stainless steel	TU555-071928XX
0 to 2" aluminium	TU555-071925XX

Several other PRUNO tools are available in store, please consult your distributor.

Plastic and stainless quick couplers

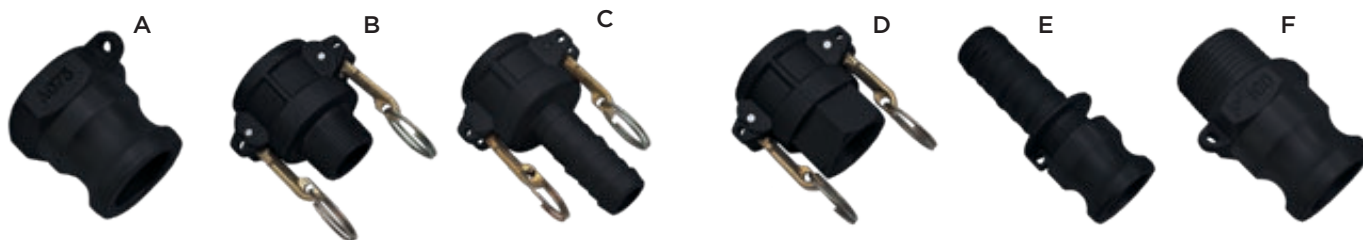

A - QUICK COUPLING	CODE	
	PLASTIC	STAINLESS
3/4"	RA780-000012M1	RA780-000012S6
1"	RA780-000016M1	RA780-000016S6
1 1/4"	RA780-000020M1	RA780-000020S6
1 1/2"	RA780-000024M1	RA780-000024S6
2"	RA780-000032M1	RA780-000032S6

D - QUICK COUPLING	CODE	
	PLASTIC	STAINLESS
1/2"	RA783-000008M1	RA783-000008S6
3/4"	RA783-000012M1	RA783-000012S6
1"	RA783-000016M1	RA783-000016S6
1 1/4"	RA783-000020M1	RA783-000020S6
1 1/2"	RA783-000024M1	RA783-000024S6
2"	RA783-000032M1	RA783-000032S6

B - QUICK COUPLING	CODE	
	PLASTIC	STAINLESS
1/2"	RA781-000008M1	RA781-000008S6
3/4"	RA781-000012M1	RA781-000012S6
1"	RA781-000016M1	RA781-000016S6
1 1/4"	RA781-000020M1	RA781-000020S6
1 1/2"	RA781-000024M1	RA781-000024S6
2"	RA781-000032M1	RA781-000032S6

E - QUICK COUPLING	CODE	
	PLASTIC	STAINLESS
1/2"	RA784-000008M1	RA784-000008S6
3/4"	RA784-000012M1	RA784-000012S6
1"	RA784-000016M1	RA784-000016S6
1 1/4"	RA784-000020M1	RA784-000020S6
1 1/2"	RA784-000024M1	RA784-000024S6
2"	RA784-000032M1	RA784-000032S6

C - QUICK COUPLING	CODE	
	PLASTIC	STAINLESS
1/2"	RA782-000008M1	RA782-000008S6
3/4"	RA782-000012M1	RA782-000012S6
1"	RA782-000016M1	RA782-000016S6
1 1/4"	RA782-000020M1	RA782-000020S6
1 1/2"	RA782-000024M1	RA782-000024S6
2"	RA782-000032M1	RA782-000032S6
4"	RA782-000064M1	RA782-000064S6

F - QUICK COUPLING	CODE	
	PLASTIC	STAINLESS
1/2"	RA785-000008M1	RA785-000008S6
3/4"	RA785-000012M1	RA785-000012S6
1"	RA785-000016M1	RA785-000016S6
1 1/4"	RA785-000020M1	-
1 1/2"	RA785-000024M1	RA785-000024S6
2"	RA785-000032M1	RA785-000032S6
4"	RA785-000064M1	-



DP - QUICK COUPLING	CODE	
	PLASTIC	STAINLESS
1/2"	RA786-000008M1	RA786-000008S6
3/4"	RA786-000012M1	RA786-000012S6
1"	RA786-000016M1	RA786-000016S6
1 1/4"	RA786-000020M1	RA786-000020S6
1 1/2"	RA786-000024M1	RA786-000024S6
2"	RA786-000032M1	RA786-000032S6

DC - QUICK COUPLING	CODE	
	PLASTIC	STAINLESS
1/2"	RA787-000008M1	RA787-000008S6
3/4"	RA787-000012M1	RA787-000012S6
1"	RA787-000016M1	RA787-000016S6
1 1/4"	RA787-000020M1	RA787-000020S6
1 1/2"	RA787-000024M1	RA787-000024S6
2"	RA787-000032M1	RA787-000032S6



LOAC TOOLS	CODE
A - Universal spout remover 15" for 5/16" & 7/16"	TU443-150507NX
A - Universal spout remover 22,5" for 5/16" & 7/16"	TU443-220507NX
A - Universal spout remover 30" for 5/16" & 7/16"	TU443-300507NX
A - Universal spout remover 40" for 5/16" & 7/16"	TU443-400507NX
B - Tapping hammer, double sided	TU440-000005XX
Tapping spout remover 12-2	TU440-120210XX

LOAC TOOLS	CODE
C - Side tie adjuster 20"	TU492-000020A1
C - Side tie adjuster 30"	TU492-000030A1
D - Multifunctions plier	TU530-000000XX
Ultra light 3/16" installation plier	TU423-600003A1
E - Ultra light 5/16" installation plier	TU423-600005A1



A



B



C



D



E

A - GALVANIZED CLAMPS	CODE
3/4"	DV217-000012XX
1"	DV217-000016XX
1 1/4"	DV217-000020XX
1 1/2"	DV217-000024XX
2"	DV217-000032XX

A - STAINLESS CLAMPS	CODE
3/4"	DV217-000012S2
1"	DV217-000016S2
1 1/4"	DV217-000020S2
1 1/2"	DV217-000024S2
2"	DV217-000032S2

B - STANDARD MAXI CLAMP	CODE
1"	DV255-003235XX
1 1/4"	DV255-004043XX
1 1/2"	DV255-004851XX
2"	DV255-006063XX

C - STAINLESS STEEL MAXI CLAMP	CODE
1"	DV255-003235S2
1 1/4"	DV255-004043S2
1 1/2"	DV255-004851S2
2"	DV255-006063S2

D - STAINLESS STEEL BALL VALVE	CODE
1/4"	VA001-000404S2
1/2"	VA001-000808S2
3/4"	VA001-001212S2
1"	VA001-001616S2
1 1/4"	VA001-002020S2
1 1/2"	VA001-002424S2
2"	VA001-003232S2

E - PVC40 THREADED BALL VALVES	CODE
1/2"	VA002-000808P2
3/4"	VA002-001212P2
1"	VA002-001616P2
1 1/4"	VA002-002020P2
1 1/2"	VA002-002424P2
2"	VA002-003232P2
2 1/2"	VA002-004040P2
3"	VA002-004848P2

E - PVC40 SLIP BALL VALVES	CODE
3/4"	VA003-001212P2
1"	VA003-001616P2
1 1/4"	VA003-002020P2
1 1/2"	VA003-002424P2
2"	VA003-003232P2
2 1/2"	VA003-004040P2
3"	VA003-004848P2

Grey PVC and white PVC40



PVC40 GUILLOTINE VALVE	CODE
1"	VA006-001616P2
1 1/2"	VA006-002424P2
2"	VA006-003232P2
3"	VA006-004848P2



SS MAINLINE COUPLINGS KIT	CODE
Couplings kit SS 3/4"	TU105-001212S2
Couplings kit SS 1"	TU105-001616S2
Couplings kit SS 1 1/4"	TU105-002020S2
Couplings kit SS 1 1/2"	TU105-002424S2
Couplings kit SS 2"	TU105-003232S2



PVC40 LINE SPRING LOADED CHECK VALVE	CODE
1/2"	VA007-000808P2
3/4"	VA007-001212P2
1"	VA007-001616P2
1 1/4"	VA007-002020P2
1 1/2"	VA007-002424P2
2"	VA007-003232P2

Grey PVC and White PVC40

Many more models available. Please contact your Lapierre representative for more details.



THE MOST COMPLETE LINE OF STAINLESS FITTINGS ON THE MARKET



BALL VALVE (INS X INS)	CODE
3/4"	VA051-001212S2
1"	VA051-001616S2



ADAPTOR (MPT X INS)	CODE
1/2"	TU100-000808S2
3/4"	TU100-001212S2
1"	TU100-001616S2
1-1/4"	TU100-002020S2
1 1/2"	TU100-002424S2
1" x 3/4"	TU100-001612S2
1 1/4" x 1"	TU100-002016S2
1 1/2" x 1 1/4"	TU100-002420S2
2" x 1 1/2"	TU100-003224S2
2"	TU100-003232S2

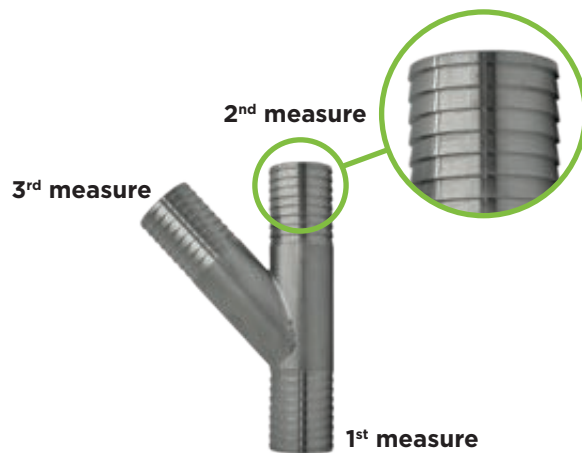

Y	CODE
3/4"	TU102-121212S2
1" x 3/4" x 3/4"	TU102-161212S2
1" x 1" x 3/4"	TU102-161612S2
1"	TU102-161616S2
1 1/4" x 1" x 1"	TU102-201616S2
1 1/4" x 1 1/4" x 3/4"	TU102-202012S2
1 1/4" x 1 1/4" x 1"	TU102-202016S2
1 1/4"	TU102-202020S2
1 1/2" x 1" x 1"	TU102-241616S2
1 1/2" x 1 1/4" x 1 1/4"	TU102-242020S2
1 1/2" x 1 1/2" x 1"	TU102-242416S2
1 1/2" x 1 1/2" x 1 1/4"	TU102-242420S2
1 1/2"	TU102-242424S2
2" x 2" x 1 1/4"	TU102-323220S2
2" x 2" x 1 1/2"	TU102-323224S2
2"	TU102-323232S2
3"	TU102-484848S2

Other sizes available

Please contact your Lapierre representative for more details.



TEE	CODE
3/4"	TU103-121212S2
1" x 1" x 3/4"	TU103-161612S2
1"	TU103-161616S2
1 1/4" x 1 1/4" x 3/4"	TU103-202012S2
1 1/4" x 1 1/4" x 1"	TU103-202016S2
1 1/4"	TU103-202020S2
1 1/2" x 1 1/2" x 1"	TU103-242416S2
1 1/2"	TU103-242424S2
2"	TU103-323232S2



SS END-PLUG WITH HOOK	CODE
3/4"	TU820-000012SS
1"	TU820-000016SS
1 1/4"	TU820-000020SS
1 1/2"	TU820-000024SS
2"	TU820-000032SS



ADAPTOR WITH HOLE (DIAL NOT INCLUDED)	CODE
Adaptor 1" MPT x INS, side hole 1/4" FPT	TU157-161604S2
Adaptor 1 1/4" x 1" MPT x INS, side hole 1/4" FPT	TU157-201604S2
Adaptor 1 1/4" MPT x INS, side hole 1/4" FPT	TU157-202004S2



COUPLING	CODE
1/2"	TU101-000808S2
3/4"	TU101-001212S2
1"	TU101-001616S2
1 1/4"	TU101-002020S2
1 1/2"	TU101-002424S2
2"	TU101-003232S2
1" x 3/4"	TU101-001612S2
1 1/4" x 1"	TU101-002016S2
1 1/2" x 1 1/4"	TU101-002420S2
2" x 1 1/2"	TU101-003224S2

Other sizes available

Please contact your Lapierre representative for more details.



DATA CER

sugarbush automation



ALWAYS ON THE LOOKOUT

THE MOST POWERFUL MONITORING AND REMOTE CONTROL SYSTEM

A CLEAR VISION OF **MAPLE SUGARING 4.0**

The DATA CER team is dedicated to the development of maple sugaring information technologies.

Our mission is to communicate data on your sugar bush's main performance indicators locally or remotely, and in real time. DATA CER enables optimal management of your workforce and priorities through access to essential sugar bush information.

Moreover, we offer remote control and pumping station equipment automation to make your life easier.

DETECTION AND **QUICK REACTION TIME**

The DATA CER system detects productivity losses in real time and allows you to respond quickly and precisely where needed.

- Save time and energy.
- Reduce the impact of seasonal stress.
- Ensure a better quality of life.
- No guessing; target the leak and fix it.
- No more overflowing sap tanks.
- Get a quick return on your investment.
- Remotely control and automate your pumping stations



DATACER Base



Vacuum transmitter (3 main lines)

Long-range transmitters can cover up to **3 MILES** of distance*

DATACER MONITORING SYSTEM	CODE
DATACER Base Includes: antenna, cable, screen, keyboard, mouse, routeur and battery backup (UPS)	SM100-020002KT
DATACER base, without antenna, cable, screen, keyboard, mouse, routeur and battery backup (UPS) (Option antenna C only)	SM100-020002NX
Vacuum transmitter (1 main line), D batteries included	SM100-010001XX
Vacuum transmitter (2 main lines), D batteries included	SM100-020001XX
Vacuum transmitter (3 main line), D batteries included	SM100-030001XX
Signal repeater, 3 D batteries included	SM100-000006XX

* In ideal field conditions. The communication depends on field topography, vegetation density and transmitters height.



A combined transmitter can measure a combination of several parameters at the same time (tank level, pressure or vacuum). For all transmitters that can measure pressure, please choose from one of the pressure sensors options listed on page 32.

COMBINED MULTI-FUNCTION TRANSMITTER			PRESSURE OPTION	OPTION ANTENNA	CODE
Transmitter P	(pressure option)	Without antenna	1, 2, 3, 4 ou 5	A, B, C	SM100-000011P
Transmitter PP	(2 pressure options)	Without antenna	1, 2, 3, 4 ou 5	A, B, C	SM100-000011PP
Transmitter PPP	(3 pressure options)	Without antenna	1, 2, 3, 4 ou 5	A, B, C	SM100-000011PPP
Transmitter PV	(pressure option, 1 vacuum)	Without antenna	1, 2, 3, 4 ou 5	A, B, C	SM100-000011PV
Transmitter PPV	(2 pressure options, 1 vacuum)	Without antenna	1, 2, 3, 4 ou 5	A, B, C	SM100-000011PPV
Transmitter PLL	(pressure option, 2 tank level by sonar)	Without antenna	1, 2, 3, 4 ou 5	A, B, C	SM100-000011PLL
Transmitter PLV	(pressure option, 1 tank level by sonar, 1 vacuum)	Without antenna	1, 2, 3, 4 ou 5	A, B, C	SM100-000011PLV
Transmitter LV	(1 tank level by sonar, 1 vacuum)	Without antenna	-	A, B, C	SM100-000011LV
Transmitter LLV	(2 tank level by sonar, 1 vacuum)	Without antenna	-	A, B, C	SM100-000011LLV

OPTION - EXTERNAL ANTENNA		CODE
Option A (standard)	Adaptor with whip antenna	SM300-000905KT
Option B	Omnidirectionnal antenna & cable 30'	SM300-030906KT
Option C	Omnidirectionnal antenna & cable 50'	SM300-050906KT

BATTERY	CODE
Battery (3) D12 PROCELL for transmitter including 1 silica gel moisture 10 gr	DV955-000012KT



MODULATION AND EMERGENCY STOP VALVE

As an option on the DATA CER station, this valve creates a restriction between your extractor and your pump to modulate the vacuum level. The modulation is either according to the external temperature or according to the vacuum set points determined. Improve the performance of your sugar bush and prevent premature freezing of your master lines through efficient vacuum management!

You can also add a float on your extractor that will cause this valve to close in case of overflow. This will add superior protection to your vacuum pump. If the extractor is located in a pumping station without a vacuum pump, then this allows you to only isolate that extractor if it overflows. Therefore, you will prevent the external vacuum hose from filling with water and then freezing. In addition, you will not penalize the vacuum supply of other areas.

MODULATION AND EMERGENCY STOP VALVE		CODE
Valve only		SM312-010032SXV
Emergency stop	(float, body 6") for vacuum modulation valve on horizontal extractor	SM512-960075XX
Emergency stop	(level switch) for vacuum modulation valve on vertical extractor	SM512-200075XX

CONTROL YOUR PUMP-STATION

Equipment control can be done manually remotely by the user or automatically based on temperature, pressure or other parameters.

- Vacuum pump Start / Stop
- Sap pump Start / Stop
- Draining valve Open / Close
- Measure the vacuum level at the extractor to benefit from the differential measurement
- Sap Extractor vacuum level modulation
- Close sap Extractor vacuum level modulation valve In case of extractor flooding
- Tank level monitoring
- R.O. Feed pump pressure monitoring after pre filters
- Pump station Indoor and outdoor temperature monitoring
- Real time operating status monitoring of: vacuum pump, sap pump and draining valve



DATA CER STATION	CODE
DATA CER station, W/O antenna * Requires antenna option (B or C) see page 30 ** Antenna option A for sugar shack station only	SM100-000012XX

DATA CER STATION (AVAILABLE OPTIONS)	CODE
Ultrasound sensor for one SS tank	SM312-000112KT
Pressure sensor 0-150 PSI (kit)	SM312-025100KT
Pressure sensor 0-300 PSI (kit)	SM312-027100KT
Water pump control by electrode, 2 HP max, 240V for one pump (electrode 60")	SM412-013260KT
Water pump control by electrode, 2 HP max, 240V for one pump (electrode 96")	SM512-013260KT
Water pump control by electrode, 3 HP max, 240V for one pump (electrode 60")	SM412-014860KT
Water pump control by electrode, 3 HP max, 240V for one pump (electrode 96")	SM512-014860KT
Water pump control by electrode, 5 HP max, 240V for one pump (electrode 60")	SM412-018060KT
Water pump control by electrode, 5 HP max, 240V for one pump (electrode 96")	SM512-018060KT
Relay for starting vacuum pump by magnetic (1 pump)	SM312-011002KT
Relay for starting vacuum pump by magnetic (2 pumps)	SM312-021002KT
1/2" air intake valve for DATA CER station	SM312-080005XX
1" drainage valve for DATA CER station	SM312-160006XX
Emergency stop (float, body 6") for vacuum modulation valve on horizontal extractor	SM512-960075XX
Emergency stop (level switch) for vacuum on vertical extractor	SM512-200075XX
Pressure sensor 0-34', cable 25' & connection 1/4" MPT	SM312-021100KT
Level sensor by pressure 0-100", cable 30' & connection 1/4" MPT	SM312-000100KT
Submersible level sensor 0-10' & cable 50'	SM312-015260KT
Submersible level sensor 0-10' & cable 100'	SM312-030260KT



PRESSURE OPTION			OPTION	CODE
Pressure sensor 0-150 PSI	Cable 25'	Connection 1/4" MPT	1	SM300-025150KT
Level sensor by pressure 0-100"	Cable 30'	Connection 1/4" MPT	2	SM300-000100KT
Pressure sensor 0-34'	Cable 25'	Connection 1/4" MPT	3	SM300-021100KT
Submersible level sensor 0-10'	Cable 50'		4	SM300-015260KT
Pressure sensor 0-300 PSI	Cable 25'	Connection 1/4" MPT	5	SM300-027100KT
Submersible level sensor 0-10'	Cable 100'		6	SM300-030260KT



TRANSMITTER FOR TANK LEVELS			OPTION ANTENNE	CODE
Transmitter I	1 tank level by sonar	Without antenna	A, B, C	SM100-010010NX
Transmitter II	2 tank levels by sonar	Without antenna	A, B, C	SM100-020010NX
Transmitter III	3 tank levels by sonar	Without antenna	A, B, C	SM100-030010NX



LONGEVITY & AGILITY MASTERY OF WATER

The most complete line of sap extractors
to perfectly suit all needs.

BERNARD AND LAPIERRE TWO NAMES ONE FAMILY

The launch of the first Lapierre maple sap extractors triggered the company manufacturing capabilities in the late 70's. Donald Lapierre designed and built the first reliable mechanical extractor on the market. Proud of our complete range of extractors, we emphasize on quality and simplicity of operation. In 2005 we acquired the sugarbush equipment manufacturer Gilles Bernard Maple Equipment to offer another interesting alternative to our customers. We kept the technical principles that made them famous but added key Lapierre Equipment manufacturing features.

SPECIFICATIONS

- Stainless steel frames, clips and fasteners;
- Standardized parts that fit on all our extractors;
- Easier than ever to take apart for cleaning and lubricating;
- All parts are CNC machined in house for a perfect fit every time;
- Manifold inlet sizes and position can be customized upon request (ask your dealer).



TWIN CONTINUOUS VACUUM EXTRACTOR (VTCV AND HTCV)

These extractors provide two bellies operating independently as a single extractor. If one stops operating, the other belly will still operate thus retaining 50% of its capacity. To enjoy this benefit, install a model that offers twice the collection capacity you need.

Sap inlet
5 x 1"

14 1/2"

Sap outlet
2 x 2"



8" X 8" X 14" VTCV EXTRACTOR

Sap inlet
7 x 1"

22 1/4"

Sap outlet
2 x 3"



12" X 36" HTCV EXTRACTOR

Sap inlet
(20" x 36") 11 x 1 1/4"

(20" x 36")
26 1/2"

Sap outlet
(20" x 36") 2 x 3"



20" X 36" HTCV EXTRACTOR

DIMENSION	TYPE	VALVE SYSTEM	O'RING KIT	DESCRIPTION	CODE
8" x 8" x 14"	VTCV	BERNARD	2 x D	Vacuum feed 1-1/2" 6" manifold	Maximum of 1500 taps 223-M6-JVC
12" x 36"	HTCV	LAPIERRE	2 x B	Vacuum feed 2" 6" manifold	Maximum of 3700 taps EX021-361236XX
12" x 36"	HTCV	BERNARD	2 x F	Vacuum feed 2" 6" manifold	Maximum of 3700 taps 218-JVC
20" x 36"	HTCV	BERNARD	2 x G	Vacuum feed 2" 6" manifold	Maximum of 12 000 taps 220-2-JVC



20" x 41" electric

ELECTRIC EXTRACTOR WITH INTERNAL PUMP

Available with one or two pumps* (internal independent) this extractor is the ultimate in continuous vacuum because it never releases its vacuum.



20" X 41" EXTRACTOR

IMPROVED MODEL

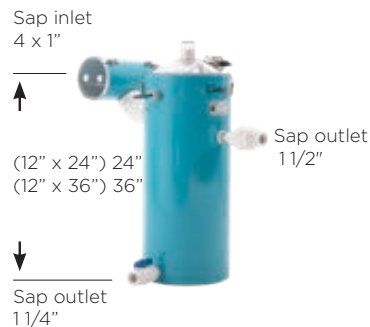

LAPIERRE 12" X 36" EXTRACTEUR

DIMENSION	PUMP	DESCRIPTION				CODE
12" x 24"	N/A	1 control	Vacuum feed 2"	6" X 12" manifold	ONLY WITH EXTERNAL PUMP (Option electrode 1)	EX010-001224NX
12" x 36"	1 pump TYPE C	1 control	Vacuum feed 2"	6" X 12" manifold	With electric float and jog button connection included (Option electrode 1)	EX110-001236XX
20" x 24"	1 pump TYPE C	1 control	Vacuum feed 3"	6" x 27" manifold	(Option electrode 2)	EX125-012024NX
20" x 24"	2 pumps TYPE C	1 control	Vacuum feed 3"	6" x 27" manifold	(Option electrode 2)	EX125-022024NX
20" x 41"	1 pump TYPE C, D, E, or H	1 control	Vacuum feed 3"	6" x 42" manifold	(Option electrode 2)	EX125-012041NX
20" x 41"	1-2 pumps TYPE C, D, E, or H	2 controls	Vacuum feed 3"	6" x 42" manifold	(Option electrode 4)	EX125-022041NX

Pumps, draining kit and electrodes pump control not included, see page 38.



20" x 41" DHS

ELECTRIC EXTRACTOR WITH INTERNAL PUMP

Now available with one, two, three or four independent internal pumps this extractor is the ultimate in continuous vacuum because it never releases its vacuum.

Sap Inlet
8 x 1 1/2"
on demand only

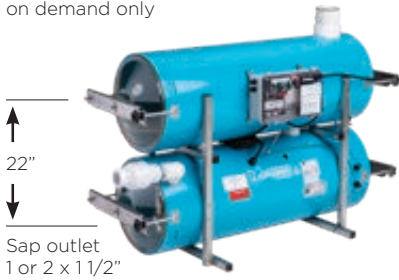

LAPIERRE 12" X 36" DHS

Sap Inlet
8 x 1 1/2"
on demand only

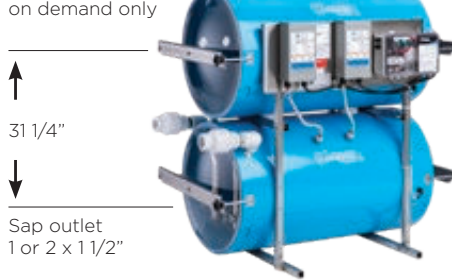

LAPIERRE 20" X 41" DHS

Sap Inlet
8 x 1 1/2"
on demand only

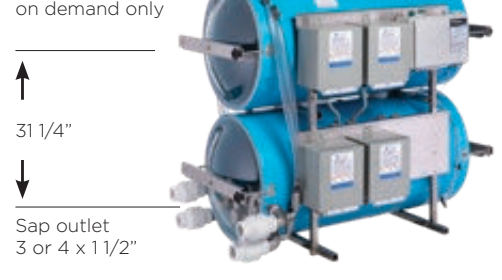

LAPIERRE 20" X 41" DHS

DIMENSION	PUMP	DESCRIPTION			CODE
12" x 36"	1 pump TYPE C or D	Electrodes control	Vacuum feed 2"	Double 12" x 36" tanks	EX127-011236XX
12" x 36"	1-2 pumps TYPE C or D	Electrodes control	Vacuum feed 2"	Double 12" x 36" tanks	EX127-021236XX
20" x 41"	1 pump TYPE C, D, E or H	Electrodes control	Vacuum feed 3"	Double stacked 20" x 41" tanks	EX129-012041XX
20" x 41"	1-2 pumps TYPEe C, D, E or H	Electrodes control	Vacuum feed 3"	Double stacked 20" x 41" tanks	EX129-022041XX
20" x 41"	1-3 pumps TYPE C, D, E or H	Electrodes control	Vacuum feed 3"	Double stacked 20" x 41" tanks	EX129-032041XX
20" x 41"	1-4 pumps TYPE C, D, E or H	Electrodes control	Vacuum feed 3"	Double stacked 20" x 41" tanks	EX129-042041XX
SINGLE TANK WITHOUT MANIFOLD					
20" x 41"	1 pump TYPE C, D, E or H	1 control	Vacuum feed 3"	Single 20" x 41" tank (Option electrode 2)	EX141-012041XX EX325-013260KN
20" x 41"	1-2 pumps TYPE C, D, E or H	2 controls	Vacuum feed 3"	Single 20" x 41" tank (Option electrode 4)	EX141-022041XX EX325-023260KN

Sap inlet holes on demand.

Electrodes pump control not included on EX141-012041XX and EX141-022041XX, see page 38.

Pump not included, see page 38. Draining kit not available for the models above.



20" x 24" HYBRID

Standard with electric float

HYBRID EXTRACTOR WITH INTERNAL WATER PUMP

This extractor, is designed to be installed on a storage tank just like a mechanical extractor, is the best of both worlds; this system is made to operate with one or two internal water pumps*. If any failure happens with the pumps, the pneumatic valve will take over and the system will operate just like a mechanical extractor. This extractor will never let you down!

Sap Inlet
(20" x 24") 7 x 1 1/4"
(20" x 41") 11 x 1 1/4"

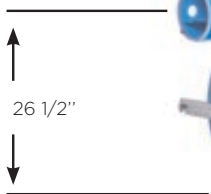

Sap outlet
(20" x 24") 1 x 1 1/2"
(20" x 41") 1 ou 2 x 1 1/2"

Flapper drain included

20" X 24" HYBRID EXTRACTOR

DIMENSION	PUMP	VALVE SYSTEM	O'RING KIT	DESCRIPTION			CODE
20" x 24"	1 pump TYPE C	BERNARD	G	Vacuum feed 2"	Manifold 6" x 27"	(Option electrode type 2)	EX126-012024BE
20" x 41"	1 pump TYPE C, D, E or H	BERNARD	J	Vacuum feed 2"	Manifold 6" x 42"	(Option electrode type 2)	EX126-012041BE
20" x 41"	1-2 pumps TYPE C, D, E or H	BERNARD	J	Vacuum feed 2"	Manifold 6" x 42"	(Option electrode type 4)	EX126-022041BE

*Pump not included, see page 38.



DRAINING KIT		CODE
draining kit on single electric horizontal extractor 20" x 24" & 20" x 41" for submersible pump		EX225-323204RT



(C-D-E-H)

Submersible pump (DEEP WELL)

TYPE	SUBMERSIBLE PUMP (DEEP WELL) FOR EXTRACTOR		CODE
C	20 GPM 1/2 HP	20 VAC = 20 GAL to 30 PSI, 0 GAL to 50 PSI	PM152-082005XX
		25 VAC = 20 GAL to 30 PSI, 0 GAL to 47 PSI	
		27 VAC = 15 GAL to 30 PSI, 0 GAL to 45 PSI	
		28 VAC = 6 GAL to 30 PSI, 0 GAL to 43 PSI	
D	25 GPM 1 HP	20 VAC = 35 GAL to 30 PSI, 0 GAL to 85 PSI	PM142-162507NX
		25 VAC = 28 GAL to 30 PSI, 0 GAL to 80 PSI	
		27 VAC = 24 GAL to 30 PSI, 0 GAL to 75 PSI	
		28 VAC = 11 GAL to 30 PSI, 0 GAL to 70 PSI	
E	25 GPM 2 HP	20 VAC = 31 GAL to 30 PSI, 0 GAL to 140 PSI	PM142-322511XX
		25 VAC = 24 GAL to 30 PSI, 0 GAL to 135 PSI	
		27 VAC = 22 GAL to 30 PSI, 0 GAL to 130 PSI	
		28 VAC = 12 GAL to 30 PSI, 0 GAL to 135 PSI	
H	60 GPM 2 HP	20 VAC = 50 GAL to 30 PSI, 0 GAL to 72 PSI	PM142-326507XX
		25 VAC = 45 GAL to 30 PSI, 0 GAL to 70 PSI	
		27 VAC = 35 GAL to 30 PSI, 0 GAL to 65 PSI	
		28 VAC = 20 GAL to 30 PSI, 0 GAL to 60 PSI	

*1 psi = 2.3 feet of elevation. (Do not forget to calculate the friction of the tube when calculating your pumps)
The above pumps are 240V, 1 HP. Possibility to have 575V, 3 HP, type D, E and H (contact Lapierre Equipment).



TYPE	ELECTRODES PUMP CONTROL OPTION FOR ELECTRIC EXTRACTOR ON NEW EXTRACTOR PURCHASE ONLY	CODE
1	2 HP max, 240V. for 1 pump on 12" and 20" DHS extractor and 12"x 36" vertical	EX325-013260KT
2	2 HP max, 240V. for 1 pump on 20" electric horizontal extractor	EX325-013260KN
	2 HP max, 575V. for 1 pump on 20" electric horizontal extractor	EX425-013260KN6
3	2 HP max, 240V. for 2 pumps on 12" and 20" DHS extractor	EX325-023260KT
4	2 HP max, 240V. for 2 pumps on 20" electric horizontal extractor	EX325-023260KN
	2 HP max, 575V. for 2 pumps on 20" electric horizontal extractor	EX425-023260KN6

ELECTRODES PUMP CONTROL OPTION FOR ELECTRIC EXTRACTOR EXTRACTOR MODIFICATION (LABOR NOT INCLUDED)		CODE
2 HP max, 240V. for 1 pump on 12" and 20" DHS extractor and 12"x 36" vertical		EX225-013260KT
2 HP max, 240V. for 1 pump on 20" electric horizontal extractor		EX225-013260KN
2 HP max, 240V. for 2 pumps on 12" and 20" DHS extractor		EX225-023260KT
2 HP max, 240V. for 2 pumps on 20" electric horizontal extractor		EX225-023260KN



12" x 36" DH

DOUBLE MECHANICAL EXTRACTOR (DV AND DH)

In these double extractors each tank operates in turn. While one is emptied of its sap, the other begins its filling cycle and vice versa. This process offers a higher collection capacity than a single extractor but less capacity compared to a twin continuous vacuum.

Sap inlet
5 x 1"



14 1/2"

Sap outlet
2 x 2"

Sap inlet
7 x 1"

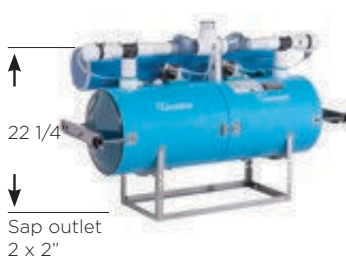

22 1/4"

Sap outlet
2 x 2"

Sap inlet
7 x 1"



22 1/2"

Sap outlet
2 x 2"

Sap inlet
(20" x 36") 11 x 1 1/4"
(20" x 48")
upon order



(20" x 36")
26 1/2"
(20" x 48")
27 3/4"

Sap outlet
(20" x 36") 2 x 3"
(20" x 48") 2 x 6"

8" X 8" X 14" DV EXTRACTOR

12" X 36" DH EXTRACTOR

12" X 12" X 18" DV EXTRACTOR

20" X 36" DH EXTRACTOR (2")

DIMENSION	TYPE	VALVE SYSTEM	O'RING KIT	DESCRIPTION			CODE
8" x 8" x 14"	DV	BERNARD	D	Vacuum feed 1"	Manifold 6"	Maximum of 1000 taps	223-M6
12" x 36"	DH	LAPIERRE	2 x B	Vacuum feed 1-1/2"	Manifold 6"	Maximum of 2500 taps	EX012-361236XX
12" x 36"	DH	BERNARD	E	Vacuum feed 1-1/2"	Manifold 6"	Maximum of 2500 taps	218
12" x 12" x 18"	DV	LAPIERRE	2 x B	Vacuum feed 1-1/2"	Manifold 6"	Maximum of 3000 taps	EX005-121806XX
12" x 12" x 18"	DV	BERNARD	E	Vacuum feed 1-1/2"	Manifold 6"	Maximum of 3000 taps	213
20" x 36"	DH	BERNARD	H	Vacuum feed 2"	Manifold 6"	Maximum of 8000 taps	220



BERNARD 12" x 36" TCV-HRS

TWIN CONTINUOUS VACUUM REVERSE SLOPE EXTRACTOR (TCV-HRS AND TCV-VRS)

These new types of reverse slope extractors now operate on the principle of twin continuous vacuum. It features 2 independent bellies operating like a single extractor while remaining a reverse slope. The necessary air leak for the proper operation of a reverse slope is now reduced and controlled. A reverse slope extractor TCV-HRS allows to raise the sap up to 20 ft @ 25 in/Hg or to 15 ft @ 20 in/Hg. The sap outlet and the vacuum feed of the reverse slope must be hooked to the manifold of the receiving extractor at the hilltop.

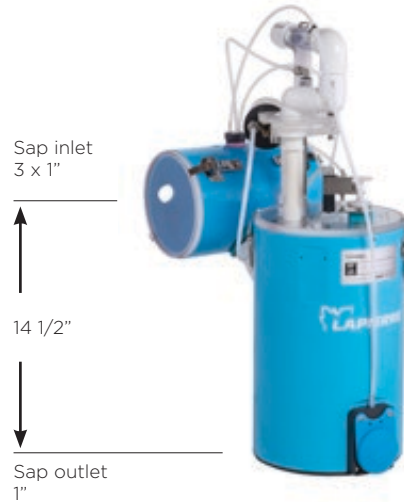

SINGLE BERNARD REVERSE SLOPE

This single reverse slope is used to push sap up toward an extractor or a transfer tank at a maximum height of 15 ft @ 20 in/Hg or 20 ft @ 25 in/Hg. It will drain itself automatically when there is no more vacuum fed to it. Unlike a conventional reverse slope extractor, it only needs one pipe for the vacuum and sap outlet.

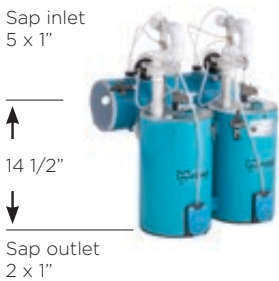

8" X 8" X 14" TVC-VRS EXTRACTOR

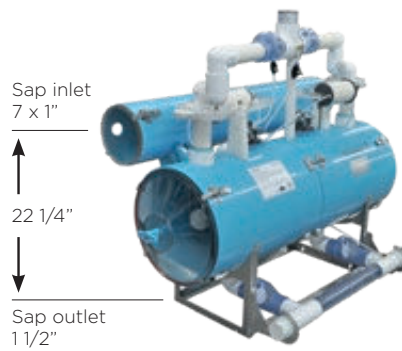

12" X 36" TVC-HRS EXTRACTOR

DIMENSION	TYPE	VALVE SYSTEM	O'RING KIT	DESCRIPTION	CODE
8" X 14"	SV-VRS	BERNARD	D	Vacuum feed 1" 6" manifold	217-M6-PI
8" x 8" x 14"	TCV-VRS	BERNARD	2 x D	Vacuum feed 2 x 1" 6" manifold	217-M6-JVC-PI
12" x 36"	TCV-HRS	BERNARD	2 x E	Vacuum feed 1 1/2" 6" manifold	218-JVC-PI
20" x 36"	TCV-HRS	BERNARD	2 x G	Vacuum feed 2" 6" manifold	220-2-JVC-PI

* The maximum amount of tap on a reverse slope extractor is related to the diameter and length of the drain pipe and the slope. Contact your Lapierre sales representative for an adequate selection.



BERNARD 20" x 24" SH

SINGLE MECHANICAL EXTRACTOR (SV AND SH)

The simplicity of operation of these single mechanical extractors makes them economic and reliable. When the sap level pushes the float up, the vacuum is cut from the belly and the sap is released.

Sap inlet
3 x 1"



Sap outlet 2"

8" X 14" SV EXTRACTOR

Sap inlet
4 x 1"



Sap outlet 2"

12" X 18" SV EXTRACTOR

Sap inlet
7 x 1"



Sap outlet 3"

12" X 24" SH EXTRACTOR

Sap inlet
7 x 1 1/4"



Sap outlet 6"

20" X 24" SH 3" EXTRACTOR

DIMENSION	TYPE	VALVE SYSTEM	O'RING KIT	DESCRIPTION			CODE
8" x 14"	SV	BERNARD	D	Vacuum feed 1"	6" manifold	Maximum of 500 taps	217-M6
12" x 18"	SV	LAPIERRE	B	Vacuum feed 1 1/2"	6" manifold	Maximum of 1200 taps	EX004-121806XX
12" x 18"	SV	BERNARD	F	Vacuum feed 1 1/2"	6" manifold	Maximum of 1200 taps	216
12" x 24"	SH	LAPIERRE	B	Vacuum feed 1 1/2"	6" manifold	Maximum of 1500 taps	EX001-271224XX
12" x 24"	SH	BERNARD	F	Vacuum feed 1 1/2"	6" manifold	Maximum of 1500 taps	210
20" x 24"	SH	BERNARD	G	Vacuum feed 2"	6" manifold	Maximum of 5000 taps	215

A



A - SAP LADDER AIR INJECTOR	CODE
Injects air in the system to move the sap up the ladder.	512

SELF CLEANING SPRINKLER OPTION

20" sap extractor self cleaning sprinklers. Only available on the superior tank of a double staked extractor.

ENSEMBLE GICLEUR & RACCORDEMENT	AVAILABLE WITH OPTION	CODE
Kit sprinkler & connection to the internal pump for manual cleaning, pump not included (on new extractor)	EX171-000020XX	EX071-000020PX
Kit sprinkler & connection to a hose for manual cleaning, hose not included (on new extractor)	EX171-000020XX	EX071-000020XX



Retrofit on existing extractors is possible. See your Lapierre dealer.

MISCELLANEOUS	CODE
Replacement sprinkler only for cleaning system	EX271-000001XX
Control kit for automatic cleaning, sprinkler not included (on new extractor)	EX171-000020XX

B



B - SAP RECOVERY DEVICE

This accessory is used to recover the sap in the bottom of a drainage tank to avoid sap loss. The ball floats allowing the sap to be siphoned by the vacuum coming from the extractor. Once the tank is emptied the ball comes down and blocks the inlet. (connected under the manifold vacuum gage).

CODE
EX107-000000XX

C



C - SAP TANK REVERSE SLOPE (FITS ON LAPIERRE STORAGE TANKS ONLY)

Used to siphon sap from a tank to a sap extractor at a maximum height of 15 ft @ 20 in/Hg and 20 ft @ 25 in/Hg automatically drains the line back to the tank when there's no more vacuum.

CODE
BA509-000024XX
BA509-000032XX

D

Sap tank reverse slope
Illustration:
with valve



D - SAP TANK REVERSE SLOPE

Used to siphon sap from a tank to a sap extractor at a maximum height of 15 ft @ 20 in/Hg and 20 ft @ 25 in/Hg. Includes automatic vacuum draining valve.	CODE	
	Automatic vacuum	Without draining valve
	520	520-S



A - Lubricants



B - Check valve for SAP extractor
2 O'rings #139 not included



C - Check valve



D - FDA flapper



E - O'rings for extractors



F - Traps and parts



G - Floats



H - Springs and hinges

A - RECOMMENDED LUBRICANTS FOR EXTRACTOR MAINTENANCE	CODE
Lapierre food grade oil 30 ml	DV492-000030XX
Food grade (silicone grease 6 g)	DV490-000001XX
Food grade (silicone grease 150 g)	DV490-000150XX

B - REPLACEMENT CHECK VALVE FOR SAP EXTRACTOR	CODE
1 1/2"	VA026-022424P4
O'ring #139	DV201-000139XX
3" Lapierre swing check valve	VA025-004848LA

C - REPLACEMENT CHECK VALVE WITH RESSORT	CODE
1"	VA026-001616P4
1 1/2"	VA026-002424P4
2"	VA026-003232P4
3"	VA026-004848P4

D - FDA FLAPPER	CODE
2" Trap alone	EX204-000021U3
3" Trap alone	EX200-000054U3
Trap FDA 2" Lapierre, Kit	EX204-000021U3KT
Trap FDA 3" Lapierre, Kit	EX200-000054U3KT

E - REPLACEMENT O'RINGS FOR EXTRACTORS	CODE
6" orange silicone	DV201-139006U2
8" orange silicone	DV201-139008U2
12" orange silicone	DV201-187012U2
20" orange silicone	DV201-187020U2

F - REPLACEMENT TRAPS AND PARTS	CODE
6" Replacement trap - Complete	EX200-000001XX
6" Evacuation trap cover only	EX200-000045XX

G - REPLACEMENT FLOATS	CODE
4" Translucent fixed float	EX205-000030XX
4" Translucent sliding float	EX207-000027NX
7 1/2" Translucent float without rod guide	EX315-000030XX
7 1/2" Translucent float, 1/8", rod guide (for Bernard reverse slope #520)	EX315-020030NX
7 1/2" Translucent float, 1/4" rod guide (for extractor)	EX315-040030NX
7 1/2" Translucent float, 5/8", rod guide (for electric control with float #432)	EX315-100030NX

H - REPLACEMENT SPRINGS AND HINGES	CODE
Replacement springs	336-B

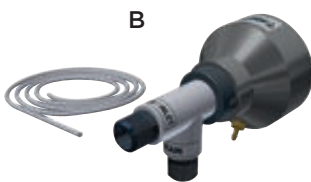

A - ALUMINUM EXTRACTOR SUPPORT RACK	CODE
3' x 1 to 12" (adjustable)	EX040-000003XX
4' x 1 to 12" (adjustable)	EX040-000004XX
5' x 1 to 12" (adjustable)	EX040-000005XX
6' x 1 to 12" (adjustable)	EX040-000006XX
7 1/2' x 1 to 12" (adjustable)	EX040-000007XX
Base plate only	EX041-011428A2

B - VACUUM DRAINING VALVE	CODE
Vacuum draining valve	PM060-000001XX
Vacuum draining valve, magnetic contact	PM060-000006XX
Vacuum draining valve, electric control	PM060-000007XX

C - EXTRACTOR LATCHES	CODE
Latch for 12" cover for horizontal extractor (unit)	EX213-000026KT
Latch for 19" cover for horizontal extractor (set of 2) (unit)	EX207-000041KT

D - STAINLESS STEEL CLIP	CODE
Stainless steel clip (with screw)	DV220-000001KT

E - STAINLESS STEEL HOOK	CODE
Stainless steel hook for clip (with screw)	DV220-000002KT

F - STAINLESS MANIFOLD STRAINER	CODE
5 3/4" x 8 1/2" for manifold 6" x 9"	EX260-092136S2
5 3/4" x 11 1/2" for manifold 6" x 12"	EX260-092184S2
5 3/4" x 18" for manifold 6" x 18 1/2"	EX260-092288S2
5 3/4" x 26 1/2" for manifold 6" x 27"	EX260-092424S2
5 3/4" x 35 1/2" for manifold 6" x 36"	EX260-092568S2
5 3/4" x 41 1/2" for manifold 6" x 42"	EX260-092664S2
7 1/2" x 41 3/4" for manifold 8" x 42"	EX260-120668S2
7 1/2" x 51 3/4" for manifold 8" x 52"	EX260-120828S2
10" x 19 3/4" for manifold 12" x 18"	EX260-160316S2
10" x 25 3/4" for manifold 12" x 24"	EX260-160412S2
10" x 37 3/4" for manifold 12" x 36"	EX260-160604S2

* Others sizes available on demand.

LED KIT	CODE
For extractor	EX080-000001XX





A



B



C



D



E



F

A - HORIZONTAL BULK TANK MANIFOLD	CODE
Manifold 6" x 27"	EX100-000627XX

B - HORIZONTAL VACUUM TRANSFER MANIFOLD	CODE
Manifold 6" x 12"	RT010-000612XX
Manifold 6" x 18"	RT010-000618XX
Manifold 6" x 27"	RT010-000627XX
Manifold 6" x 36"	RT010-000636XX
Manifold 6" x 42"	RT010-000642XX
Manifold 6" x 48"	RT010-000648XX

C - VERTICAL VACUUM TRANSFER TANK	CODE
12" x 18"	RT003-001218XX
12" x 24"	RT003-001224XX
12" x 36"	RT003-001236XX

D - VERTICAL VACUUM TRANSFER TANK WITH FRAME	CODE
20" x 24" vertical booster tank with frame	RT008-002024XX
20" x 36" vertical booster tank with frame	RT008-002036XX

E - HORIZONTAL VACUUM TRANSFER TANK	CODE
12" x 18" horizontal booster tank without frame	RT001-001218XX
12" x 18" horizontal booster tank with frame	RT002-001218XX
12" x 24" horizontal booster tank without frame	RT001-001224XX
12" x 24" horizontal booster tank with frame	RT002-001224XX
12" x 36" horizontal booster tank without frame	RT001-001236XX
12" x 36" horizontal booster tank with frame	RT002-001236XX

F - HORIZONTAL VACUUM TRANSFER TANK	CODE
20" x 24" horizontal booster tank without frame	RT001-002024XX
SS frame for 20" x 24"	EX207-202409S5
20" x 36" horizontal booster tank without frame	RT001-002036XX
SS frame for 20" x 36"	EX207-203609XX



KIT	CODE
Pressure relief adaptor kit	PM010-00000SS

LAPIERRE HIGH PRESSURE TRANSFER PUMP				CODE
1/2 HP	7 Turbines	5 gal @ 100 PSI / 0 gal @ 130 PSI		PM012-080705XX
3/4 HP	11 Turbines	5 gal @ 135 PSI / 0 gal @ 185 PSI		PM012-121105XX
1 HP	14 Turbines	5 gal @ 200 PSI / 0 gal @ 255 PSI		PM012-161405XX
1 1/2 HP	17 Turbines	5 gal @ 230 PSI / 0 gal @ 300 PS		PM012-241705XX
1/2 HP	4 Turbines	10 gal @ 60 PSI / 0 gal @ 90 PSI		PM012-080410XX
3/4 HP	7 Turbines	10 gal @ 80 PSI / 0 gal @ 130 PSI		PM012-120710XX
1 HP	9 Turbines	10 gal @ 110 PSI / 0 gal @ 170 PSI		PM012-160910XX
1 1/2 HP	14 Turbines	10 gal @ 150 PSI / 0 gal @ 250 PSI		PM012-241410XX
2 HP	18 Turbines	10 gal @ 180 PSI / 0 gal @ 325 PSI		PM012-321810XX
3/4 HP	6 Turbines	15 gal @ 70 PSI / 0 gal @ 130 PSI		PM012-120615XX
1 HP	8 Turbines	15 gal @ 100 PSI / 0 gal @ 150 PSI		PM012-160815XX
1 1/2 HP	10 Turbines	15 gal @ 100 PSI / 0 gal @ 190 PSI		PM012-241015XX
2 HP	14 Turbines	15 gal @ 150 PSI / 0 gal @ 260 PSI		PM012-321415XX
3 HP	17 Turbines	15 gal @ 180 PSI / 0 gal @ 325 PSI		PM012-481715XX
3/4 HP	6 Turbines	20 gal @ 65 PSI / 0 gal @ 100 PSI		PM012-120620XX
1 HP	7 Turbines	20 gal @ 75 PSI / 0 gal @ 115 PSI		PM012-160720XX
1 1/2 HP	8 Turbines	20 gal @ 90 PSI / 0 gal @ 130 PSI		PM012-240820XX
2 HP	11 Turbines	20 gal @ 120 PSI / 0 gal @ 175 PSI		PM012-321120XX
3 HP	14 Turbines	20 gal @ 175 PSI / 0 gal @ 235 PSI		PM012-481420XX
5 HP	20 Turbines	20 gal @ 285 PSI / 0 gal @ 430 PSI		PM012-802020XX
3/4 HP	4 Turbines	25 gal @ 45 PSI / 0 gal @ 65 PSI		PM012-120425XX
1 HP	5 Turbines	25 gal @ 55 PSI / 0 gal @ 85 PSI		PM012-160525XX
1 1/2 HP	8 Turbines	25 gal @ 70 PSI / 0 gal @ 112 PSI		PM012-240825XX
2 H	10 Turbines	25 gal @ 105 PSI / 0 gal @ 60 PSI		PM012-321025XX
3 HP	12 Turbines	25 gal @ 140 PSI / 0 gal @ 200 PSI		PM012-481225XX
5 HP	21 Turbines	25 gal @ 240 PSI / 0 gal @ 340 PSI		PM012-802125XX
5 HP	5 Turbines	80 gal @ 80 PSI / 0 gal @ 115 PSI		PM262-050075HX

GOULDS PUMPS

All the listed pumps are 120/240 Volts single phase
 Also available: 208/230/460/575 Volts three phase.



GOULDS PUMP			CODE
1/2 HP	1 ST	20 gal @ 20 PSI / 0 gal @ 28 PSI	PM020-000008XX
3/4 HP	1 ST	35 gal @ 20 PSI / 0 gal @ 35 PSI	PM020-000012XX
1 HP	1 ST	40 gal @ 25 PSI / 0 gal @ 45 PSI	PM020-000016XX
1 1/2 HP	1 ST	40 gal @ 35 PSI / 0 gal @ 52 PSI	PM020-000024XX
2 HP	1 ST	40 gal @ 40 PSI / 0 gal @ 62 PSI	PM020-000032XX
3 HP	1 ST	45 gal @ 50 PSI / 0 gal @ 70 PSI	PM020-000048XX
1 1/2 HP	2 ST	85 gal @ 20 PSI / 0 gal @ 30 PSI	PM022-000024XX
2 HP	2 ST	90 gal @ 25 PSI / 0 gal @ 35 PSI	PM022-000032XX
3 HP	2 ST	100 gal @ 30 PSI / 0 gal @ 45 PSI	PM022-000048XX
5 HP	2 ST	105 gal @ 45 PSI / 0 gal @ 60 PSI	PM022-000080XX
1 1/2 HP	3 ST	90 gal @ 15 PSI / 0 gal @ 22 PSI	PM023-000024XX
2 HP	3 ST	110 gal @ 20 PSI / 0 gal @ 27 PSI	PM023-000032XX
3 HP	3 ST	148 gal @ 20 PSI / 0 gal @ 36 PSI	PM023-000048XX
5 HP	3 ST	165 gal @ 20 PSI / 0 gal @ 45 PSI	PM023-000080XX

GOULDS PUMP LB SERIES		CODE
1/2 HP	20 gal @ 25 LB / 5 gal @ 45 LB / 0 gal @ 55 LB	PM019-000008XX
1 HP	20 gal @ 40 LB / 5 gal @ 75 LB / 0 gal @ 80 LB	PM019-000016XX

SUBMERSIBLE PUMP (DRAIN) (240 VOLTS)		CODE
3/4 HP	submersible pump Goalds 0,75 HP 1PH 230V	PM145-001201XX
1 HP	submersible pump Goalds 1 HP 1 HP 230V	PM145-001601XX



BANJO FILTER	CODE
3/4"	PM061-001212XX
1"	PM061-001616XX
1 1/4"	PM061-002020XX
1 1/2"	PM061-002424XX
2"	PM061-003232XX

VACUUM POWERED SAP PISTON PUMP

Unique to Lapierre Equipment, these pumps allow sap to be pumped a great distance without electricity. Proven reliability since 1996.

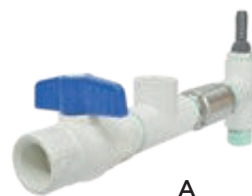

A

B



C

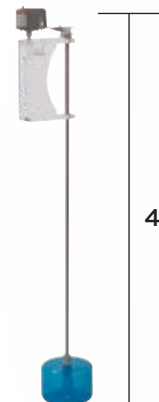

U-CUP	CODE
8" Replacement U-cup not included (for all sizes)	DV200-000875XX

SINGLE ACTION WITH SINGLE VACUUM CYLINDER	CODE
300 USG/Hr @ 66'/elevation or 30 psi @ 20 in/Hg	PM015-000101XX
Replacement seal kit	DV200-001001KT

SINGLE ACTION WITH DUAL VACUUM CYLINDER	CODE
225 USG/Hr @ 132'/elevation or 60 psi @ 20 in/Hg	PM015-000102XX
Replacement seal kit	DV200-002001KT

DUAL ACTION WITH SINGLE VACUUM CYLINDER	CODE
450 USG/Hr @ 66'/elevation or 30 psi @ 20 in/Hg	PM015-000201XX
Replacement seal kit	DV200-001002KT

DUAL ACTION WITH DUAL VACUUM CYLINDER	CODE
340 USG/Hr @ 132'/elevation or 60 psi @ 20 in/Hg	PM015-000202XX
Replacement seal kit	DV200-002002KT

A - 1" PUMP CONNECT KIT	CODE
With SS spring valve	PM405-010016XX

B - TANK ELECTRIC CONTROL	CODE
24"	BA401-000024XX
36"	BA401-000036XX
48"	BA401-000048XX
54"	BA401-000054XX
60"	BA401-000060XX

C - BERNARD ELECTRIC TANK CONTROL COMPLETE WITH FLOAT	CODE
48"	432
60"	432-60
72"	432-72

Comparative Table of Technologies Available on the Maple Sugaring Market

	ADVANTAGES	RISKS/DISADVANTAGES
Oil-lubricated rotary vane vacuum pumps	<ul style="list-style-type: none"> › Vacuum level of 29.9" Hg › Wide range of flow rates › Constant flow rate from the atmospheric pressure to the end vacuum › Simple design › Quiet operation 	<ul style="list-style-type: none"> › Risk of oil contamination by sap › Risk of oil expulsion between 0-20" Hg <p>Maintenance:</p> <ul style="list-style-type: none"> - Frequent oil and filter changes - Wear of vanes if maintenance is faulty
Dry claw vacuum pumps	<ul style="list-style-type: none"> › Vacuum level of 28.4" Hg › Constant flow rate from the atmospheric pressure to the end vacuum › Constant flow rate over time (no wear parts) › Simple design › Quiet operation › Proven technology in maple syrup production <p>Maintenance:</p> <ul style="list-style-type: none"> - Almost non-existent - No fluid in the compression chamber 	<ul style="list-style-type: none"> › More limited vacuum level on models over 130 CFM (27" or 25.5" Hg)
Dry-running rotary vane vacuum pumps	<ul style="list-style-type: none"> › Simple design › Quiet operation 	<ul style="list-style-type: none"> › Vacuum level limited to 25.5" Hg › Low capacity vs power output (less CFM for the same HP) › Capacity loss of up to 30% because of vane wear › Risk of clogging with the mixture of maple sap vapors, sugar and carbon powder <p>Maintenance:</p> <ul style="list-style-type: none"> - Frequent and expensive vane changes
Liquid ring vacuum pumps	<ul style="list-style-type: none"> › Vacuum level of 28.9" Hg (double stage) › Wide range of flow rates › Quiet operation › Tolerant to maple sap <p>Maintenance:</p> <ul style="list-style-type: none"> - Almost non-existent 	<ul style="list-style-type: none"> › Low capacity vs power output (less CFM for the same HP) › Variable performance based on water temperature › Water consumption › Complex oil recirculation system
Lubricated screw vacuum pumps	<ul style="list-style-type: none"> › Vacuum level of 29.9" Hg › Wide range of flow rates › Quiet operation 	<ul style="list-style-type: none"> › Variable performance › Actual consumption higher than the motor power rating › Complex design with multiple components at greater risk of failure › Electronic system often required for operation › Risk of oil contamination from maple sap <p>Maintenance:</p> <ul style="list-style-type: none"> - Frequent oil changes and part replacement - Complex and expensive on-site maintenance

THE VACUUM PUMP EVERY SUGARMAKER TALKS ABOUT, BUILT FOR HIGH VACUUM!



- Rotary claws dry pump;
- No friction;
- Air cooled, no water or oil;
- Pollution free clean operation;
- Simple construction yet robust;
- Minimal maintenance;
- Can operate via VFD;
- Very low electrical consumption;
- Very low noise operation.



PROGRESSIVE START VARIABLE SPEED DRIVE

- Can be hooked-up to any existing auto start and stop system;
- No need for external magnetic starter;
- Manual RPM adjustment;
- Progressive start to eliminate high power peaks;
- Convert single phase power to 3 phase;
- Electrical hook-up should be handled by a certified electrician.

BASE ON CASTERS (BUSCH VACUUM PUMP)	CODE
Base for 0040	PM420-004000D1
Base for 1102, 1142, 1144	PM420-110200D1
Base for 1252, 1322	PM420-125200D1

BASE ON CASTERS (BUSCH R5 MODEL)	CODE
Base for R0025, R0040	PM430-025040D1
Base for R0063, RA100	PM430-063100D1
Base for R0165, R0205, R0255 R0305	PM430-165305D1



FILTER IN WASHABLE FABRIC



SPARE AIR FILTER CARTRIDGE (BUSCH VACUUM PUMP)	CODE
MM1144, MV0040B, RA0025 and RA0040 pump	PM325-532002XX
MM1142, MM1102, RA0063 and RA0100 pump	PM325-532003XX
MM1252, MM1322, RA0165, RA0205, RA0255 and RA0305 pump	PM325-532004XX
RC0021 pump	PM325-532005XX

GEAR BOX OIL	CODE
VS150, 1 liter (BUSCH MINK VACUUM PUMPS)	PM327-164883XX

HOOKS LUBRICANT	CODE
500 ml (Busch vacuum pump)	PM428-034500ML



MINK BUSCH PUMP MV0040 12 SCFM @ 15" (MAX. : 28,7 IN/HG)	CODE
14CFM with 1-3/4 HP motor with variable speed 1.24KW, 1 HP, 220V Intake filter assembly and adaptor included	PM120-004001XX

BUSCH VACUUM PUMPS ARE AVAILABLE IN 3 DIRECT DRIVE CONFIGURATIONS:

Single phase motors with fixed speed. Three phase 230/460 or 575 volts, can use a variable frequency drive for energy consumption reduction up to 50%, and lower amp requirements to start the pump.

PUMP MM1144BV	29 SCFM @ 15" (MAX. : 28,5 PO/HG)	CODE
Single phase motor	220 Volts / 3 HP	PM120-114403XX
3 phase motor	230/460 V / 3 HP	PM121-114402XX
3 phase motor	575 V / 3 HP	PM121-114402AX
Progressive start control	1 HP 220 V to 3 HP 230 / 460 V	PM421-114402XX
Progressive start control	600 V 3 HP à 600V 3 HP	PM421-114403AX
Connection kit for progressive start	Miscellaneous parts	EL421-114400XX

PUMP MM1102BV	40 SCFM @ 15" (MAX. : 28,5 PO/HG)	CODE
Single phase motor	220 V / 5 HP	PM120-110205XX
3 phase motor	230/460 V / 5 HP	PM121-110203XX
3 phase motor	575 V / 5 HP	PM121-110203AX
Progressive start control	1 HP 220 V to 3 HP 230/460 V	PM421-110205XX
Connection kit for progressive start	Miscellaneous parts	EL421-114200XX



Includes exhaust flap, lubrication valve, intake filter. Electrical hook-up should be handled by a certified electrician. The connection kit for progressive start includes everything needed to connect the vacuum pump to the controller. Cable 8'.

PUMP MM1142BV	52 SCFM @ 15" (MAX.: 28,5 PO/HG)	CODE
Single phase motor	220 V / 7,5 HP	PM120-114207XX
3 phase motor	230/460 V / 7,5 HP	PM121-114204XX
3 phase motor	575 V / 7,5 HP	PM121-114204AX
Progressive start control	1 HP 220 V to 3 HP 230/460 V	PM421-114204XX
Progressive start control	600 V 3 HP to 600V 3 HP	PM421-114204AX
Connection kit for progressive start	Miscellaneous parts	EL421-114200XX

PUMP MM1252AV	83 SCFM @ 15" (MAX.: 27 PO/HG)	CODE
Single phase motor	220 V / 10 HP	PM120-125210XX
3 phase motor	230/460 V / 7,5 HP	PM121-125205XX
3 phase motor	575 V / 7,5 HP	PM121-125205AX
Progressive start control	1 HP 220 V to 3 HP 230/460 V	PM421-125205XX
Progressive start control	600 V 3 HP to 600 V 3 HP	PM421-125205AX
Connection kit for progressive start	Miscellaneous parts	EL421-125200XX

PUMP MM1322AV	100 SCFM @ 15" (MAX.: 25,5 PO/HG)	CODE
Single phase motor	220 V / 12,5 HP	PM120-132212XX
3 phase motor	230 / 460 V / 10 HP	PM121-132206XX
3 phase motor	575 V / 10 HP	PM121-132206AX
Progressive start control	1 HP 220 V to 3 HP 230/460 V	PM421-132206XX
Progressive start control	600 V 3 HP to 600 V 3 HP	PM421-132206AX
Connection kit for progressive start	Miscellaneous parts	EL421-132200XX

BUSCH R5

Since 1963, Busch Vacuum Technics has been manufacturing the most efficient and robust vacuum pumps in the industry. Being the first to manufacture and optimize oil-lubricated rotary vane pumps as we know them today, Busch R 5 vane pumps are still today considered the industry benchmark because of their robustness and high operational reliability. More than 3 million of R 5 vacuum pumps are now used worldwide for a variety of demanding industrial applications. Their high efficiency at low vacuum, their energy efficiency and the efficiency of the the exhaust box filtration system invented by Dr. Ing. Karl Busch make this pump a powerful and reliable equipment for maple producers who want to operate at low vacuum. Initially developed for the food industry, the Busch R 5 pumps has a high tolerance to water vapor, an optimal low energy consumption and air flow over the entire vacuum range.



Includes with BUSCH R5 Vacuum pump: exhaust flap, intake filter. Electrical hook-up should be handled by a certified electrician. The connection kit for progressive start includes everything needed to connect the vacuum pump to the controller. Cable 8'.

PUMP R0021 (OIL 2 L)	6 SCFM @ 15" (MAX.: 29,3 PO/HG)	CODE
Single phase motor	120 V / 1,2 HP	PM130-002101XX
Single phase motor	220 V / 1,2 HP	PM130-012101XX

PUMP R0025 (OIL 2 L)	9 SCFM @ 15" (MAX.: 29,9 PO/HG)	CODE
Single phase motor	110/220 V / 1,5 HP	PM130-002501XX
3 phase motor	230/460 V / 1,5 HP	PM131-002501XX
3 phase motor	600 V / 1,5 HP	PM131-002501AX
Progressive start control	220 V 1 HP to 230/460 V 3 HP	PM421-002501XX
Progressive start control	600 V 3 HP to 600 V 3 HP	PM421-006303AX
Connection kit for progressive start	Miscellaneous parts	EL421-114200XX

PUMP R0040 (OIL 2 L)	14 SCFM @ 15" (MAX.: 29,9 PO/HG)	CODE
Single phase motor	110/220 V / 2 HP	PM130-004002XX
3 phase motor	230/460 V / 2 HP	PM131-004002XX
3 phase motor	600 V / 2 HP	PM131-004002AX
Progressive start control	220 V 1 HP to 230/460 V 3 HP	PM421-006303XX
Progressive start control	600 V 3 HP to 600 V 3 HP	PM421-006303AX
Connection kit for progressive start	Miscellaneous parts	EL421-114200XX

PUMP R0063 (OIL 3 L)	23 SCFM @ 15" (MAX.: 29,9 PO/HG)	CODE
Single phase motor	220 V / 3 HP	PM130-006303XX
3 phase motor	230/460 V / 3 HP	PM131-006303XX
3 phase motor	600 V / 3 HP	PM131-006303AX
Progressive start control	220 V 1 HP to 230/460 V 3 HP	PM421-006303XX
Progressive start control	600 V 3 HP to 600 V 3 HP	PM421-006303AX
Connection kit for progressive start	Miscellaneous parts	EL421-114200XX

PUMP R0100 (OIL 3 L)	36 SCFM @ 15" (MAX.: 29,9 PO/HG)	CODE
Single phase motor	220 V / 5 HP	PM130-010005XX
3 phase motor	230/460 V / 5 HP	PM131-010005XX
3 phase motor	600 V / 5 HP	PM131-010005AX
Progressive start control	220 V 1 HP to 230/460 V 3 HP	PM421-010005XX
Progressive start control	600 V 3 HP to 600 V 3 HP	PM421-010005AX
Connection kit for progressive start	Miscellaneous parts	EL421-114200XX

PUMP R0165 (OIL 7 L)	58 SCFM @ 15" (MAX.: 29,9 PO/HG)	CODE
Single phase motor	220 V / 7,5 HP	PM130-016507XX
3 phase motor	230/460 V / 7,5 HP	PM131-016507XX
3 phase motor	600 V / 7,5 HP	PM131-016507AX
Progressive start control	220 V 1 HP to 230/460 V 3 HP	PM421-016507XX
Progressive start control	600 V 3 HP to 600 V 3 HP	PM421-016507AX
Connection kit for progressive start	Miscellaneous parts	EL421-125200XX

PUMP R0205 (OIL 7 L)	65 SCFM @ 15" (MAX.: 29,9 PO/HG)	CODE
Single phase motor	220 V / 7,5 HP	PM130-020507XX
3 phase motor	230/460 V / 7,5 HP	PM131-020507XX
3 phase motor	600 V / 7,5 HP	PM131-020507AX
Progressive start control	220 V 1 HP to 230/460 V 3 HP	PM421-020507XX
Progressive start control	600 V 3 HP to 600 V 3 HPH	PM421-020507AX
Connection kit for progressive start	Miscellaneous parts	EL421-125200XX

PUMP R0255 (OIL 7 L)	85 SCFM @ 15" (MAX.: 29,9 PO/HG)	CODE
Single phase motor	220 V / 10 HP	PM130-025510XX
3 phase motor	230/460 V / 10 HP	PM131-025510XX
3 phase motor	600 V / 10 HP	PM131-025510AX
Progressive start control	220 V 1 HP to 230/460 V 3 HP	PM421-025510XX
Progressive start control	600 V 3 HP to 600 V 3 HP	PM421-025510AX
Connection kit for progressive start	Miscellaneous parts	EL421-132200XX

PUMP R0305 (OIL 7 L)	98 SCFM @ 15" (MAX.: 29,9 PO/HG)	CODE
3 phase motor	230/460 V / 10 HP	PM131-030510XX
Progressive start control	230 V 1 HP to 230/460 V 3 HP	PM421-030510XX
Progressive start control	600 V 3 HP to 600 V 3 HP	PM421-030512AX
Connection kit for progressive start	Miscellaneous parts	EL421-132200XX

PUMP R0400, 20 HP	153 SCFM @ 15" (MAX.: 29,9 IN/HG) SEE YOUR SALES REPRESENTATIVE FOR DETAILS
--------------------------	--

PUMP R0630, 25 HP	228 SCFM @ 15" (MAX.: 29,9 IN/HG) SEE YOUR SALES REPRESENTATIVE FOR DETAILS
--------------------------	--

NEW

• COBRA: DRY SCREW VACUUM PUMPS



The COBRA NC pump is a dry twin screw pump. Two screws are counter rotating inside the cylinder. The gas is sucked in by the screws, compressed and conveyed to the exhaust of the pump. This process is done without any friction or contact between the screws nor the internal body of the pump. Cooling is done with two possible configuration. The first one is an open system with an internal cooling circuit needing external water supply. The second option is a closed system via a liquid/air configuration with a radiator, no external cooling needed.

The COBRA pumps are very efficient and are perfect for applications that need stable and reliable extraction without oil contamination of the gazes and vapors. Get the best of both worlds of a MINK and R5 with the COBRA. A dry pump with an end vacuum level of an oil pump. The end vacuum is 29,9"Hg and contrary to the competition's screw pumps, it needs no oil in the compression chamber due to its advanced design.

Reliable & heavy-duty

The variable pitch of the screws and the free discharge of the gases offers a high combability to solids particles and liquids as well as a high tolerance to water vapor. The unique thermal distribution and the anti-friction coating results in highly resistant to corrosion screws resulting in extreme durability.

Compatible with a variable frequency drive and a wide range of accessories are available for this product.

PUMP NC0450	124 SCFM @ 15" (MAX.: 29,9 PO/HG)	CODE
3 phase motor	230/460 V / 15 HP	PM171-045015XX
3 phase motor	230/460 V / 15 HP (with radiator)	PM172-045015XX
Progressive start control	220 V 1 HP to 230/460 V 3 HP	PM421-045015XX

OIL LUBRICANT R5 PUMP	CODE
Oil R-530S (1 L)	PM328-000001SX
Oil R-530 (20 L)	PM328-000020XX
Oil R-580 (1 L) for model 0021 only	PM328-580001XX

OIL FILTER FOR R5 PUMP	CODE
Model 0160, 0165, 0205, 0250, 0255 & 0305	PM329-531001XX
Model 0025, 0040, 0063 & 0100	PM329-531002XX

EXHAUST FILTER KIT FOR THE R5 PUMP	CODE
Model 0021	PM329-993120XX
Model 0025, 0040	PM329-993134XX
Model 0063	PM329-993194XX
Model 0100	PM329-993902XX
Model 0165, 0205 & 0255	PM329-993908XX

Service parts



**LIQUID RING
VACUUM PUMP**

LAPIERRE EQUIPMENT
QUALITY ASSEMBLY

Single stage

Single stage
up to 25.5 in/Hg



SIHI pump available
with progressive start
variable speed drive.

3404	CODE
Sihi pump, SS turbine, 20 CFM @ 15 in/Hg with 3 HP motor, frame, coupling and shield	PM106-003404S6

3408	CODE
Sihi pump, SS turbine, 38 CFM @ 15 in/Hg with 5 HP motor, frame, coupling and shield	PM106-003408S6

OPTIONS (3404 AND 3408)	CODE
Connection fittings	PM108-003404XX
Muffler 1 1/2"	PM465-000305XX

40412	CODE
Sihi pump, SS turbine, 62 CFM @ 15 in/Hg with 7,5 HP motor, frame, coupling and shield	PM106-040412S6
Connection fittings	PM108-040412XX
Muffler 2"	PM465-000007XX

40517	CODE
Sihi pump, SS turbine, 82 CFM @ 15 in/Hg with 10 HP motor, frame, coupling and shield	PM106-040517S6
Connection fittings	PM108-040517XX
Muffler 1 1/2"	PM465-000010XX

Close coupled single stage

Close-coupled single stage up to 27.5 in/Hg



LEMR 15 3/4 HP	CODE
3,5 CFM @ 15 in/Hg	PM110-000015S6
Connection fittings	PM108-000015XX

LEMR 20 1 HP	CODE
6,75 CFM @ 15 in/Hg	PM110-000020S6
Connection fittings	PM108-000020XX

Double stage

Double stage up to 28.5 in/Hg



3704	CODE
Sihi pump, SS turbine, 18 CFM @ 15 in/Hg with 5 HP motor, frame, coupling and shield	PM106-003704S6

3708	CODE
Sihi pump, SS turbine, 35 CFM @ 15 in/Hg with 7,5 HP motor, frame, coupling and shield	PM106-003708S6

OPTIONS 3704 AND 3708	CODE
Connection fittings	PM108-003404XX
Muffler 1 1/2"	PM465-000305XX

45312	CODE
Sihi pump, SS turbine, 46 CFM @ 15 in/Hg with 7,5 HP motor, frame, coupling and shield	PM106-045312S6
Connection fittings	PM108-040412XX
Muffler 2"	PM465-000007XX

45317	CODE
Sihi pump, SS turbine, 54 CFM @ 15 in/Hg with 10 HP motor, frame, coupling and shield	PM106-045317S6
Connection fittings	PM108-045317XX
Muffler 2"	PM465-000007XX

SERVICE LIQUID TANK (FOR LIQUID RING VACUUM PUMP)	CODE
18" x 36" x 34" 66 gal (79 USG) (comes with overflow pipe)	BA001-180334S3

SUPPORT FOR SIHI VACUUM PUMP (WALL MOUNTING)	CODE
Set of 2 (16" x 16")	PM468-321616XX



GUZZLER ELECTRIC SINGLE DIAPHRAGM PUMP	CODE
GE-0401N, 3/4 - 1 1/4", 115 V, up to 400 taps	PM007-040116NX
GE-0404N, 3/4 - 1 1/4", 24 V, up to 400 taps	PM067-040424NX
Service kit (diaphragm & flapper valves)	PM407-000017XX

GUZZLER ELECTRIC DOUBLE DIAPHRAGM PUMP	CODE
G2-0501N, 1 1/4", 115 V, up to 800 taps	PM008-050116NX
G2-0504N, 1 1/4", 24 V, up to 800 taps	PM009-050424NX
Service kit (diaphragm & flapper valves)	PM408-000017FX

NEW



EMERGENCY STOP VALVE FOR EXTRACTOR WITH 1 1/2" & 2" CONNECTION AND FLOAT ON 1" MPT ADAPTOR

This system prevent sap overflow from the sap extractor shutting off the vacuum feed by the signal of an adjustable float located inside the extractor. The valve will reopen ten seconds after the float signal is lost. The valve must be installed vertically on the upmost portion of extractor vacuum feed.

EMERGENCY STOP VALVE	CODE
FOR EXTRACTOR WITH 1 1/2" & 2" CONNECTION AND FLOAT ON 1" MPT ADAPTOR	EX075-010032XX



A - TESTER	CODE
CFM tester	PM199-00001KT

VACUUM OIL	CODE
68 high performance 18.9 L (5 USG)	DV461-006818XX
100 flood 18,9 L (4,99 USG)	DV461-010018XX

B - MAGNETIC STARTER (240 VOLTS, 1 HP AUTO/OFF/ON)	CODE
3 HP	PM380-000003XX
5 HP	PM380-000005XX
7.5 HP	PM380-000007XX
10 HP	PM380-000010XX

C - VERTICAL HUMIDITY TRAP	CODE
2" ball	TH002-000002NX
3" ball	TH002-000003NX

D - CONTROL TEMPERATURE CONNEXION	CODE
for drive and magnetic starter (120 Volts)	EL521-419001XX

E - VERTICAL ELECTRIC HUMIDITY TRAP	CODE
14" X 25 1/2" with 3" inlet and outlet, 3" flap included	TH003-031425XX

F - BERNARD HUMIDITY TRAP	CODE
Built-in lateral water sight level and drain (electric switch included)	507-D

* It is strongly recommended to add the vacuum breaker valve option.

G - 3/4" VACUUM BREAKER VALVE	CODE
3/4" Vacuum breaker valve	TH060-120001XX
With options (valve, elbow and nipple)	TH060-120001KT

VACUUM REGULATOR	CODE
H - Vacuum regulator 1 1/2" (Fits on 1 1/2" male and 2" female)	PM400-000001XX
I - High flow vacuum regulator	PM400-000002XX

A COMPLETE RANGE OF SS STORAGE TANKS

- Made with first grade materials;
- Structural metal chosen according to tank size to satisfy the most demanding sugarmakers;
- Side reinforcement bars made to strengthen the sides when tank is full to the top (4 feet and bigger);
- All aluminum frames on 3' x 4' and smaller storage tanks;
- Full steel structure on 4' x 6' tanks and up.

DIMENSION WIDTH	DIMENSION LENGTH	OUTLET
2', 3', 4', 5'	up to 8'	1 1/2" mâle NPT
more than 5'	more than 8'	2" mâle NPT
6', 7 1/2'	any length	2" mâle NPT



18" WIDE	IMP G.	USG	LITERS	BRIGHT ANNEALED 304-BA
18" x 4' x 26 1/4"	63	76	288	BA001-180426S3
18" x 4' x 34"	88	105	397	BA001-180434S3

2' WIDE	IMP G.	USG	LITERS	BRIGHT ANNEALED 304-BA
2' x 4' x 29"	98	117	443	BA001-020429S3
2' x 4' x 41"	148	177	670	BA001-020441S3

3' WIDE	IMP G.	USG	LITERS	BRIGHT ANNEALED 304-BA
3' x 4' x 36 3/4"	193	231	874	BA001-030436S3
3' x 4' x 48 3/4"	267	321	1215	BA001-030448S3
3' x 8' x 24"	217	260	984	BA001-030824S3
3' x 8' x 37 1/2"	385	462	1749	BA001-030837S3
3' x 8' x 49 1/2"	535	642	2430	BA001-030849S3
3' x 12' x 37 1/2"	578	693	2623	BA001-031237S3
3' x 12' x 49 1/2"	802	963	3645	BA001-031249S3
3' x 16' x 37 1/2"	770	924	3498	BA001-031637S3
3' x 16' x 49 1/2"	1070	1283	4857	BA001-031649S3

NO SPACER NEEDED TO CONNECT TO DRAIN FITTINGS

Our special design gives you clearance.

MPT STAINLESS STEEL OUTLET OPTION ON TANK

Overflow od drain welded in the tank. See page 64. Option 3" outlet instead of 2" on tank 5', 6' and 7 1/2' wide. Contact your Lapierre representative for more information. *Important : the tank will be 2" higher if outlet of 3",

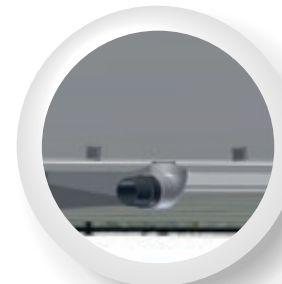

4' WIDE	IMP. G	USG	LITERS	BRIGHT ANNEALED 304-BA
4' x 4' x 33 1/4"	216	259	980	BA001-040433S3
4' x 4' x 45 1/4"	316	379	1435	BA001-040445S3
4' x 8' x 33 1/4"	432	519	1964	BA001-040833S3
4' x 8' x 45 1/4"	632	758	2869	BA001-040845S3
4' x 8' x 52 3/4"	757	908	3437	BA001-040852S3
4' x 12' x 33 1/4"	648	778	2945	BA001-041233S3
4' x 12' x 45 1/4"	948	1137	4304	BA001-041245S3
4' x 12' x 52 3/4"	1135	1362	5156	BA001-041252S3
4' x 12' x 60"	1310	1572	5950	BA001-041260S3
4' x 16' x 33 1/4"	864	1037	3925	BA001-041633S3
4' x 16' x 45 1/4"	1264	1516	5739	BA001-041645S3
4' x 16' x 52 3/4"	1513	1816	6874	BA001-041652S3
4' x 16' x 60"	1746	2095	7930	BA001-041660S3
4' x 20' x 45 1/4"	1580	1896	7177	BA001-042045S3
4' x 20' x 33 1/4"	1081	1297	4909	BA001-042033S3
4' x 20' x 52 3/4"	1892	2270	8593	BA001-042052S3



- Superior quality construction;
- Heavy duty structure;
- Extra structure to minimize support points.



CUSTOMIZABLE NAME ON THE FRONT PLATE

5' WIDE	IMP. G	USG	LITERS	BRIGHT ANNEALED 304-BA
5' x 8' x 29 1/4"	438	525	1987	BA001-050829S3
5' x 8' x 41 1/4"	687	824	3119	BA001-050841S3
5' x 8' x 50 1/2"	879	1055	3994	BA001-050850S3
5' x 8' x 64 1/4"	1165	1398	5292	BA001-050864S3
5' x 8' x 84"	1576	1891	7158	BA001-050884S3
5' x 12' x 29 1/4"	656	788	2983	BA001-051229S3
5' x 12' x 41 1/4"	1031	1237	4683	BA001-051241S3
5' x 12' x 50 1/2"	1319	1583	5992	BA001-051250S3
5' x 12' x 64 1/4"	1748	2098	7942	BA001-051264S3
5' x 12' x 84"	2364	2837	10739	BA001-051284S3
5' x 16' x 29 1/4"	875	1050	3975	BA001-051629S3
5' x 16' x 41 1/4"	1374	1649	6242	BA001-051641S3
5' x 16' x 50 1/2"	1759	2111	7991	BA001-051650S3
5' x 16' x 64 1/4"	2331	2797	10588	BA001-051664S3
5' x 16' x 84"	3152	3783	14320	BA001-051684S3
5' x 20' x 29 1/4"	1094	1313	4970	BA001-052029S3
5' x 20' x 41 1/4"	1718	2061	7802	BA001-052041S3
5' x 20' x 50 1/2"	2198	2638	9986	BA001-052050S3
5' x 20' x 64 1/4"	2913	3496	13234	BA001-052064S3
5' x 20' x 84"	3940	4728	17897	BA001-052084S3
5' x 24' x 41 1/4"	2061	2473	9361	BA001-052441S3
5' x 24' x 64 1/4"	3495	4195	15880	BA001-052464S3
5' x 24' x 84"	4728	5674	21478	BA001-052484S3

STORAGE | STAINLESS TANKS

6' WIDE	IMP. G	USG	LITERS	BRIGHT ANNEALED 304-BA
6' x 8' x 49 1/2"	1009	1211	4584	BA001-060849S3
6' x 8' x 61 1/2"	1309	1570	5943	BA001-060861S3
6' x 8' x 73 1/2"	1608	1930	7306	BA001-060873S3
6' x 8' x 84"	1875	2250	8517	BA001-060884S3
6' x 12' x 49 1/2"	1514	1816	6874	BA001-061249S3
6' x 12' x 61 1/2"	1963	2355	8915	BA001-061261S3
6' x 12' x 73 1/2"	2412	2894	11296	BA001-061273S3
6' x 12' x 84"	2812	3375	12776	BA001-061284S3
6' x 16' x 49 1/2"	2018	2422	9168	BA001-061649S3
6' x 16' x 61 1/2"	2617	3141	11890	BA001-061661S3
6' x 16' x 73 1/2"	3216	3859	14608	BA001-061673S3
6' x 16' x 84"	3750	4499	17031	BA001-061684S3
6' x 20' x 49 1/2"	2523	3027	11458	BA001-062049S3
6' x 20' x 61 1/2"	3271	3926	14862	BA001-062061S3
6' x 20' x 73 1/2"	4020	4824	18261	BA001-062073S3
6' x 20' x 84"	4687	5624	21289	BA001-062084S3
6' x 24' x 49 1/2"	3027	3633	13753	BA001-062449S3
6' x 24' x 61 1/2"	3926	4711	17833	BA001-062461S3
6' x 24' x 73 1/2"	4824	5789	21914	BA001-062473S3
6' x 24' x 84"	5624	6749	25548	BA001-062484S3

7 1/2' WIDE	IMP. G	USG	LITERS	BRIGHT ANNEALED 304-BA
7 1/2' x 8' x 66"	1760	2113	7999	BA001-070866S3
7 1/2' x 8' x 84"	2322	2786	10546	BA001-070884S3
7 1/2' x 12' x 66"	2641	3169	11996	BA001-071266S3
7 1/2' x 12' x 84"	3483	4179	15819	BA001-071284S3
7 1/2' x 16' x 66"	3521	4225	15993	BA001-071666S3
7 1/2' x 16' x 84"	4644	5573	21096	BA001-071684S3
7 1/2' x 20' x 66"	4401	5281	19991	BA001-072066S3
7 1/2' x 20' x 84"	5805	6966	26369	BA001-072084S3
7 1/2' x 24' x 66"	5281	6338	23992	BA001-072466S3
7 1/2' x 24' x 84"	6966	8359	31642	BA001-072484S3

STAINLESS STEEL SAP SILO

DIMENSION	GAL IMP.	GAL US	CODE
8' x 8'	2500	3000	BA002-008008SS
8' x 10'	3000	3600	BA002-008010SS
8' x 12'	3750	4500	BA002-008012SS
8' x 15'	4700	5640	BA002-008015SS
8' x 25'	7200	8366	BA002-008025SS
10' x 12'	5500	6600	BA002-010012SS
10' x 15'	6625	7950	BA002-010015SS
10' x 20'	9000	10800	BA002-010020SS
10' x 25'	11620	14000	BA002-010025SS
12' x 15'	10000	12000	BA002-012015SS
12' x 20'	13850	16620	BA002-012020SS
12' x 25'	17500	21000	BA002-012025SS

INCLUDED ACCESSORIES

- Access door on top
- Access door at the base
or 2 ladders (12' silos and less)
- Access door at the base
and 2 ladders (15' silos and more)
- Air vent with screen
- Rotary washing ball
- Inlet and overflow on 2" (5.08 cm)
ferrule or threaded
- Outlet on 3" (7.62 cm) ferrule
or threaded
- Standardized ladders, walkway
and guardrails

OPTIONS FOR STAINLESS STEEL SAP SILO	CODE
Logo	BA102-000000XX
Exterior ladder 15'	BA102-020015XX
Exterior ladder 20'	BA102-020020XX
Exterior ladder 25'	BA102-020025XX
Protection cage for 15' ladder	BA102-040015XX
Protection cage for 20' ladder	BA102-040020XX
Protection cage for 25' ladder	BA102-040025XX
Upper gateway 8' diameter	BA102-030008XX
Upper gateway 10' diameter	BA102-030010XX
Upper gateway 12' diameter	BA102-030012XX
Overflow 4" only instead of 2" or 3"	BA102-060064XX
Top feed plumbing, option 2"	BA102-050032XX
Top feed plumbing, option 3"	BA102-050048XX
Top feed plumbing, option 4"	BA102-050064XX
Overflow outlet plumbing down, option 4"	BA102-070064XX
Stainless steel wash ball feed plumbing	BA102-090000XX
Additional bottom outlet 1 1/2", 2", 3" or 4"	BA102-080000XX
Building stainless steel connection box	BA102-100000XX
Attachment plate for piping kit	BA102-110000XX
Top railing	BA102-120000XX
Top hatch	BA102-130000XX

HORIZONTAL SAP SILO IN STAINLESS STEEL

DIMENSION	GAL IMP.	GAL US	CODE
12' x 25'	17500	21000	BA022-012025SS

STAINLESS STEEL TRANSPORT TANK

DIMENSION	GAL IMP.	GAL US	CODE
46" x 5'	358	430	BA008-046005SS
46" x 6'	431	518	BA008-046006SS
54" x 8'	791	950	BA008-054008SS
54" x 10'	999	1200	BA008-054010SS
54" x 12'	1187	1425	BA008-054012SS
76" x 10'	1957	2350	BA008-076010SS
76" x 12'	2352	2825	BA008-076012SS
76" x 15'	2939	3530	BA008-076015SS
76" x 20'	3914	4700	BA008-076020SS
8' x 25'	7190	8628	BA008-008025SS

STAINLESS STEEL TRANSPORT TANK WITHOUT ANTI-WAVE

DIMENSION	GAL IMP.	GAL US	CODE
46" x 5'	358	430	BA018-046005SS
46" x 6'	431	518	BA018-046006SS



To order overflow pipes by specific sizes, please follow this procedure

1-1/2" PVC Drain overflow pipe (BA404-01**24XX)

2" PVC Drain overflow pipe (BA404-01**32XX)

3" PVC Drain overflow pipe (BA404-00**48XX)

From the generic code, replace the 2 stars by the length of the pipe.
Example: PVC Drain overflow pipe 1 1/2" x 11" long: BA404-011124XX.

Our machined drain outlets will precisely fit with our tank overflow pipes.



FILTERING BAG	CODE
Round disk (hole 1 1/2")	DV436-000024M1
Round disk (hole 2")	DV436-000032M1
Round disk (hole 3")	DV436-000048M1
10" Filtering bag (cordless)	DV435-000010XX
16" Filtering bag (cordless)	DV435-000016XX
20" Filtering bag (cordless)	DV435-000020XX
30" Filtering bag (cordless)	DV435-000030XX

HORIZONTAL LEG TANK	CODE
20" x 29" 29 imp. gal (35 USG)	BA008-000035H1
23" x 43" 54 imp. gal (65 USG)	BA008-000065H1

Other sizes available on demand only. Transport fees can be applied.

SUPPORT	CODE
Support for tank footboard	BA399-170001XX



COMPLETE DRAIN	CODE
1 1/2", SS, MPT	BA606-000024S2
2", SS, MPT	BA606-000032S2
3", SS, MPT	BA606-000048S2



PERSONALIZED PANEL FOR STAINLESS STEEL TANK	CODE
white resin amerlock 2 paint alimentary grade (catalyst included)	DV465-000006XX

Quantity: 1 gal. of paint and 1 gal. of catalyst.

PERSONALIZED PANEL FOR STAINLESS STEEL TANK	CODE
1 side	BA001-000001XX
2 sides	BA001-000002XX

OVERFLOW SS OR DRAIN WELDED ON SS TANK	CODE
1 1/4"	BA850-000020S2
1 1/2"	BA850-000024S2
2"	BA850-000032S2
3"	BA850-000048S2

Can be positioned as per customer's need.

STORAGE TANK LADDER	CODE
16" x 42" Ladder	BA412-016042A1
16" x 53" Ladder	BA412-016053A1
16" x 66" Ladder	BA412-016066A1



WITH ITS EXPANDABLE DESIGN, OUR UPDATED RANGE OF R.O.'S WILL CONTINUALLY GIVE YOU MORE!

UPGRADE TO A HIGHER STANDARD IN NO TIME

Nowadays, R.O.'s are essential pieces of equipment for maple syrup producers in a world-class economy. By removing more than 50% to 95% of the water contained in the sap, the use of an R.O. results in substantial savings in the fuel used for evaporation.

The scalable construction of Lapierre R.O.'s mounted on a stainless steel frame allows components such as pumps and housings to be upgraded to optimize the performance of your equipment to achieve the desired throughput.

Lapierre's high efficiency recirculation design allows your R.O. to operate at a high Brix level throughout the day, without washing or rinsing the membranes (under recommended conditions).

By optimizing the capacity of our high-pressure pumps and choosing the right motors, we are proud to offer you the most energy-efficient range of high-performance R.O.'s on the market.

No other brand of R.O. has such a high resale value on the market.

UNMATCHED RELIABILITY AND SIMPLICITY

- Choice of 5 HP high pressure pumps of 10 or 20 GPM according to your needs
- Increased performance through an easy addition of membranes, high pressure pump, booster pump, etc.
- Wheeled system for effortless movement

INCLUDED WITH PURCHASE

- Stainless steel wash tank
- Membrane and storage canister
- 20" pre-filter and pre-filter protector
- Lubricant for sealing joints
- Connection pipe
- Membrane cap and adaptor
- Membrane soap

THE R.O. SPECIALIST

We are experts at customizing your R.O. to your specific needs.

Our proven expertise in maple syrup production enables us to optimize the performance of equipment from other manufacturers.

THE LOWEST ENERGY CONSUMPTION ON THE MARKET STANDARD: 230 V / 1 PHASE

AVAILABLE: 600 V / 3 PHASE / 208 / 230 3 PHASE

FOR EXAMPLE:

**3000 SERIES 5 HP
2 MEMBRANES: 42 AMPS**

**5000 SERIES
12 MEMBRANES: 131 AMPS**



10000 SERIES

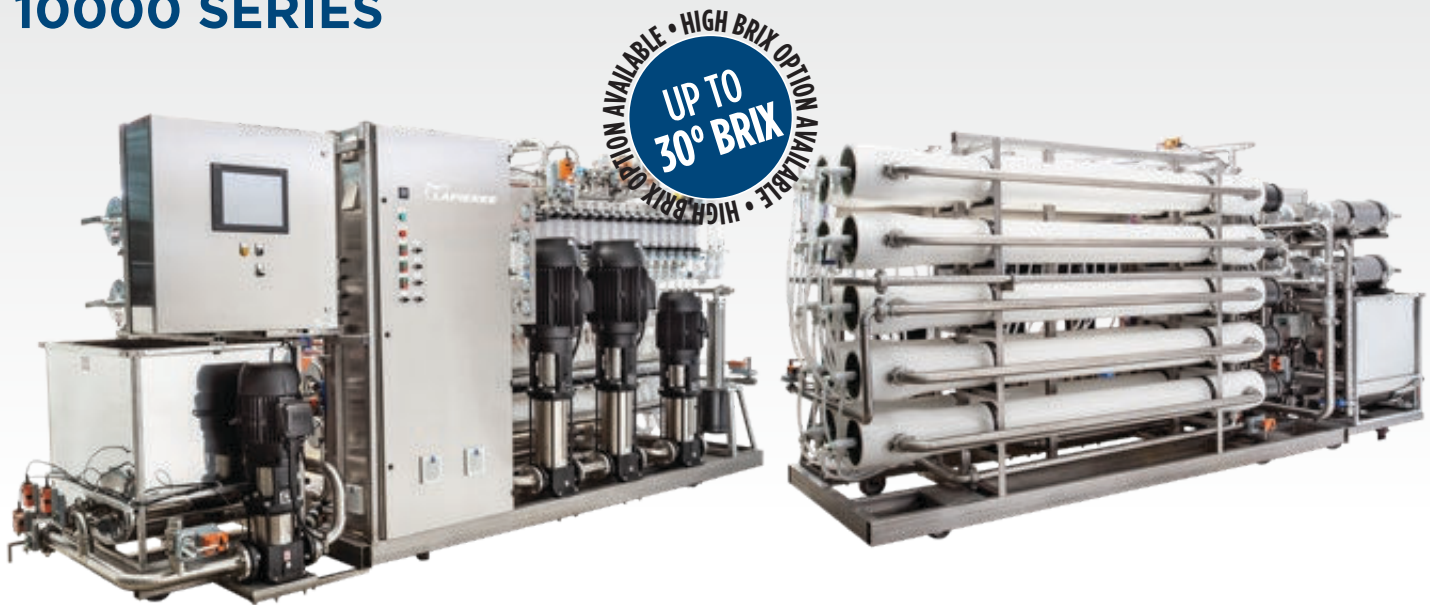

OUR INDUSTRIAL GRADE R.O.

TOUGHER FOR BETTER PERFORMANCE!

Lapierre is proud to present the very first industrial grade R.O. developed with ingenuity and optimized for large-scale maple syrup operations. Unparalleled in durability and operating flexibility, the 10K Series, mounted on a solid frame and made entirely of stainless steel, has been designed to meet the most demanding maple syrup producers' performance requirements.

Powerful and compact, the horizontal configuration of the 10000 Series, as well as its all-stainless steel filter unit installed above the wash tank, greatly improves maintenance operations. For maximum efficiency, the 10000 Series allows up to 15 double membrane systems, for a total of 30 membranes. That's serious performance!

CONFIGURATIONS

- Up to 30 membranes in 15 double housings with 1.5 HP recirculation
- 1 feed pump with variable speed drive
- 2 high-pressure pumps with variable speed drive
- 1 to 3 booster pump(s) with variable speed drive
- Stainless steel sap filters with 6 cartridges for concentration
- Stainless steel sap filters with 6 cartridges for washing

AVAILABLE OPTIONS

- Stainless steel 10 gal flowmeter bracket
- Element, thermostat and water level control on wash tank
- Automation system

5000 SERIES



UP TO 30° BRIX
HIGH BRIX OPTION AVAILABLE • HIGH BRIX OPTION AVAILABLE



AN R.O. THAT KEEPS ITS PROMISES

The 5000 Series has proven itself to be the industry's highest performing equipment. A single pass for a concentration of 20 Brix or more makes it the system with the lowest power consumption rate in the industry. The 5000 Series is also built on a stainless steel frame and has a scalable design that can accommodate up to 12 membrane systems (6 single and 6 double for a total of 18 membranes) as well as all the pumps in a complementary configuration. High performance for days on end!

STANDARD CONFIGURATIONS (UP TO 20° BRIX / 25° BRIX WITH A BOOSTER PUMP)

	15 HP / 9 MEMBRANES	15 HP / 12 MEMBRANES	20 HP / 15 MEMBRANES	25 HP / 18 MEMBRANES
Feed pump	Goulds 5 HP 2St	Goulds 5 HP 2St	Goulds 5 HP 2St	7.5 HP + variable
High pressure pump	3 x 5 HP 20 GPM	3 x 5 HP 20 GPM	4 x 5 HP 20 GPM	5 x 5 HP 20 GPM
Simple box 3/4 HP	3	4	5	6
Double box 1 1/2 HP	3	4	5	6
Wash tank	3' x 3'	3' x 3'	3' x 4'	3' x 4'
Stainless steel water filter with 6 cartridges for concentration	2	3	4	4
Stainless steel water filter with 6 cartridges for washing	1	1	1	1

AVAILABLE OPTIONS

- Stainless steel rack for flowmeter 10GPM (9, 12, 15 or 18 kit)
- Element, thermostat and water level control on wash tank
- Automation system
- 1 or 2 booster pump(s)
- Wash pump



UP TO 30° BRUX
HIGH BRUX OPTION AVAILABLE • HIGH BRUX OPTION AVAILABLE



3000 SERIES

A little gem for producers with more than 3000 taps who are looking for performance and a concentration of 18 Brix or more. This is an R.O. mounted on a stainless steel frame with 5 hp-20 gal high pressure pumps and a scalable configuration allowing operation of up to 8 stainless steel housings. Raw power!

STANDARD CONFIGURATIONS (UP TO 20° BRUX)

MODEL TURBO	TURBO HP PUMP	FEED PUMP	SIMPLE VESSEL 8"	DOUBLE VESSEL 8"
TURBO 5 HP	1 x 5 HP (20 GPM)	2 HP Goulds	2	0
TURBO 10 HP	2 x 5 HP (20 GPM)	5 HP Goulds	4	0
TURBO 15 HP	3 x 5 HP (20 GPM)	5 HP Goulds	6	0

MODULAR CONFIGURATION WITH BOOSTER PUMP (UP TO 25° BRUX)

MODEL TURBO	TURBO HP PUMP	FEED PUMP	SIMPLE VESSEL 8"	DOUBLE VESSEL 8"
TURBO 10 HP	2 x 5 HP (20 GPM)	5 HP Goulds	2	2
TURBO 15 HP	3 x 5 HP (20 GPM)	5 HP Goulds	3	3

Options for the 3000 and 3000 ELITE Series

- Two 5 way quick connect valves for concentrate and filtrate
- Concentrate and filtrate valve panel (3000 only)
- Optional stainless steel feed pump cover and high pressure pump cover (3000 only)
- Continuous Brix reader or AUTOBRUX valve including continuous Brix reader
- Various sizes of rectangular stainless steel wash tank with filtration installed on the tank (3000 only)
- Element and thermostat on wash tank
- Magnetic box and water level control on wash tank
- Up to 8 recirculations
- Horizontal support for SS housings
- SS housing in polished stainless steel
- Filtrate sampler for ss housing
- Booster pump
- Flowmeter panel for filtrate with samplers
- Filtrate flowmeter 20 additional gallons
- Addition of pre-filters for concentration and washing
- Sap filter with fabric or 6 cartridges
- 35 gallon flowmeter

Many possible configurations when purchasing an R.O. with a 5 HP turbo pump.

NEW



Photo : 3K ELITE with modular membrane vessel rack

3000 ELITE SERIES

A new star is born. This newcomer to the Lapierre R.O. family stands out for its ingenious design and all stainless steel construction. The integrated wash tank allows for minimal plumbing, ease of operation and an unmatched look. High pressure pumps are controlled by VFD for a better control of the pressure and to optimize energy efficiency of the R.O.

Available with automated option, 3K ELITE



CONFIGURATION STANDARD (UP TO 20° BRUX)

MODEL ELITE	TURBO HP PUMP	FEED PUMP	SIMPLE VESSEL 8"	DOUBLE VESSEL 8"
ELITE 5 HP	1 x 5 HP (20 GPM)	2 HP Goulds	2	0
ELITE 10 HP	2 x 5 HP (20 GPM)	5 HP Goulds	4	0
ELITE 15 HP	3 x 5 HP (20 GPM)	5 HP Goulds	6	0

MODULAR CONFIGURATION WITH BOOSTER PUMP (UP TO 25° BRUX)

MODEL ELITE	TURBO HP PUMP	FEED PUMP	SIMPLE VESSEL 8"	DOUBLE VESSEL 8"
ELITE 10 HP	2 x 5 HP (20 GPM)	5 HP Goulds	2	2
ELITE 15 HP	3 x 5 HP (20 GPM)	5 HP Goulds	3	3

HYPERBRIX™ R.O. (UP TO 35° BRUX)



HYPERBRIX® R.O. Technology will save you time and energy. 2 Brix sap to 35 Brix concentrate in one single pass!

You have not seen everything yet in R.O. sap concentration technology! Lapierre's HYPERBRIX®, process can reduce the volume of water to be evaporated by 95%.

- Each HYPERBRIX® R.O. is paired with a HYPERBRIX® evaporator especially adapted for the task of cooking syrup from 35 Brix concentrate, with an emphasis on flavour development;
- The process developed by Lapierre retains all the elements present in the sap, resulting in uncompromising maple syrup;
- HYPERBRIX® technology is the solution for achieving the lowest maple syrup production cost.



NEW

3k, 5k and 10k automated systems

Lapierre R.O.'s have been continually evolving for more than 30 years. With the most complete product family in the industry, we can meet the needs of the smallest producers all the way up to industrial maple syrup operations.

We are proud to introduce our brand new Lapierre R.O. automation system, designed to improve and simplify maple syrup production. You can control it remotely from anywhere on the planet! This provides optimal performance and simplifies its operation while providing live production data via the dashboard.

If necessary, this equipment can be operated in both automatic and manual modes.

- Access to the machine at all times via the Internet
- Concentrate and filtrate flows, continuous Brix level, operating pressures, maple filtrate and concentrate water reservoir levels, operating mode
- Automatic start according to the level of the sap tank level.
- Remote control of operations: concentration, washing, rinsing, desugaring, Pep, Brix levels, start/stop, etc.
- Alarms classified by importance and transmitted by email in real time
- 12-inch easy to use and user-friendly touch screen
- Automatic purging to facilitate feed pump start-up
- Automatic washing
- Automatic quick action valves
- Integrated WiFi and VPN routers
- Unique feature that toggles from automatic to manual mode at the touch of a button, allowing instrument operation and reading (pressures, flow rates and temperature) without using the controller.
- Multi-tank management option (allows management of filling and concentration up to 6 tanks of sap, concentrate or filtrate)



2000 SERIES

The 2000 Series is the R.O. of choice for producers operating a sugar bush with more than 1000 taps. Built with a stainless steel frame, it can be mounted with a high pressure pump of 3 HP-5 GPM or 5 HP-10 GPM. It is also pre-wired to connect two membranes.

2000 Series

STANDARD CONFIGURATIONS (UP TO 20° BRIX)

MODEL	TURBO HP PUMP	FEED PUMP	MEMBRANE + SS BOX 4"	MEMBRANE + SS BOX 8"	TANK	PREFILTER
TURBO 3 HP	1 x 3 HP (5 GPM)	1/2 HP Goulds	1	-	R32	1
TURBO 3 HP	1 x 3 HP (5 GPM)	1/2 HP Goulds	2	-	R32	1
TURBO 5 HP	1 x 5 HP (10 GPM)	1 HP Goulds	-	1	R32	1
TURBO 5 HP	1 x 5 HP (10 GPM)	1 HP Goulds	-	2	R32	2

Options for 2000 Series 3 HP and 5 HP

- 2 5-way quick-connect valves for concentrate and filtrate
- Concentrate and filtrate valve panel
- Optional stainless steel feed pump cover and high pressure pump cover
- Continuous Brix reader
- AUTOBRIX valve including continuous Brix reader
- Rectangular 29 gal stainless steel wash tank with filtration installed on the tank
- Element, thermostat and water level control on wash tank

Options for 2000 Series 5 HP only

- SS Polished Stainless Steel Housing (only for 8" housing)
- Filtrate sampler for SS housing
- Flowmeter panel for filtrate with samplers
- Addition of pre-filters for concentration and washing
- Sap filter with fabric or 6 cartridges

Many possible configurations when purchasing an R.O. with a 5 HP turbo pump.



NEW

1000 SERIES

Designed for traditional production and smaller operations, our 1000 series R.O.'s with 1 or 2 vessels offers guaranteed joy for maple syrup producers. If the R.O. reduces the boiling time and the amount of wood used to produce maple syrup, the 1000 series captivates with its remarkable ease of operation.

This range is PURE CONCENTRATED JOY for all its users.

1000 SERIES

MODEL	TURBO HP PUMP	FEED PUMP	MEMBRANE + SS BOX 4"	TANK	PREFILTER	VALVE PANEL
100	1 x 2 HP	3/4 HP	1	Integrated	1	Optional
200	1 x 2 HP	3/4 HP	2	Integrated	1	Optional

Performance

1 Vessel 250 to 750 Taps

2 Vessels 750 to 1,000 Taps

Concentration Up to 8 Brix in optimal conditions

Options

- Stainless steel wash tank
- Expansion kit (2nd vessel)
- Preventive maintenance kit

Electrical components

- 3/4 HP feed pump
- Integrated 2 HP high pressure and recirculation pump
- Voltage: 240 volts; current: 16 amps

Stainless steel components

- Integrated frame and handles
- 4 in. (10.16 cm) vessel
- Pump vessels
- Piping

R.O.'S REMOTE CONTROL SYTEM

Offered as an option on our concentrators, this system is a simplified version of the automation already offered on our reverse osmosis systems. It simplifies operations and allows remote control of your R.O. via the touch screen of the main computer located near the reverse osmosis machine, via a remote computer or via a mobile device.

This system is offered at a very competitive price, and easily integrates with all our previous concentrator models, as well as most of the competition R.O.'s.

System Details

- 4 cycle operations: concentration, desugaring, washing and rinsing.
- Cycle settings: duration, choice of high-pressure pumps used and Brix level (with the integrated Autobrix option).
- Feedback: current cycle stage, filter outlet pressure, Brix level (with the integrated Autobrix option).
- Web interface for remote connection to perform several operations on the concentrator from a remote computer or mobile device.
- Emergency breaker to enter manual mode in the event of control problems.
- Sensor and valve testing adjustments via the main computer touch screen.
- Touch screen on the main computer to operate multiple operations on the R.O.



2 TO 24 FLOW METER PANELS

Available with or without sampling valve.
Ask your agent about the various possible configurations.



5-WAY VALVE	CODE
3/4" with o'ring outlets	CN235-000012RX
1" with o'ring outlets	CN235-000016RX
1 1/4" with o'ring outlets	CN235-000020RX
Engraved mounting plate - Concentrated	CN236-000001S5
Engraved mounting plate - Filtrate	CN236-000002S5
Mounting plate - rear	CN236-000003S4
Non-engraved mounting plate folded back	CN236-010003S4



VALVE PANEL



VALVE PANEL (CONCENTRATE)	CODE
1/2"	CN120-080812XX
3/4"	CN120-121212XX

VALVE PANEL (FILTRATE)	CODE
1"	CN120-161612XX
1 1/4"	CN120-202012XX
1 1/2"	CN120-242412XX

PREFILTRATION

Pre-filtration is essential for the proper operation of an R.O. We have a wide selection of practical and high-performance cloth or cartridge filters.

Be sure that your existing R.O. has a pre-filtration system appropriate to its capacity. Talk to your Lapierre representative about it.



BLUE HOUSING AND PRE-FILTER	CODE
Blue housing 2" x 20", 10 to 12 gal. capacity	CN206-002003XX
Purtrex 20" 5 micron pre-filter (1)	DV402-052001NX
Purtrex 20" 5 micron pre-filter (20)	DV402-052001NXB
Pre-filter protector (5)	DV401-000005XX
Tubular pre-filter protector (6)	DV401-000006XX
Plastic key for blue housing	CN206-150295XX

LATERAL SUPPORT	CODE
For 2 pre-filters	CN423-071202S2



COMPLETE MODIFICATION KIT TO TRANSFORM A STD SAP FILTER INTO A 6-CARTRIDGE SAP FILTER	CODE
<ul style="list-style-type: none"> - Cartridges not included; - Suitable for Lapierre sap filters from the year 2000 and up; - For older filters, confirm compatibility. 	FE202-240614XX

MAINTENANCE PRODUCTS	CODE
Membrane soap TFC 1.13 kg	CN400-000000XX
Membrane soap TFC 11 kg	CN400-000011XX
Lubri-teck (glycerine) 1 litre	DV424-000001XX
Lubri-teck (glycerine) 4 litres	DV424-000004XX
SMBS preservative 1.5 kg	CN405-000001XX
Propylene glycol 4 litres	DV427-000004XX
Ph 10-12 test paper strip	DV243-000000XX
Ph 1-10 test paper strip	DV243-000112XX

24" LAPIERRE SAP FILTER WITH 6 PRE-FILTERS 40 gal capacity (pre-filtered water) 20 gal capacity (non-pre-filtered water) / max. 75 PSI	CODE
Complete sap filter 1" inlet	FE002-240616XX
Complete sap filter 1 1/4" inlet	FE002-240620XX
Complete sap filter 1 1/2" inlet	FE002-240624XX

Uses the same pre-filters as the blue housing.

24" LAPIERRE CLOTH SAP FILTER 15 GAL / MAX. CAPACITY 75 PSI	CODE
2 filter cloths included Complete sap filter 1" inlet	FE001-000016XX
Complete sap filter 1 1/4" inlet	FE001-000020XX
Complete sap filter 1 1/2" inlet	FE001-000024XX
5 micron filter cloth (1)	DV400-002401XX
1 micron filter cloth (1)	DV400-012401XX

Lapierre sap filter also available with stainless housing



FILTRATE SAMPLER	CODE
3/4" MPT x 3/4" MPT for Lapierre housing	CN410-000001XX
1/2" FPT x 1/2" MPT for Seprotech housing	CN410-000002XX

Several models can accommodate the housings of other brands.

NEW

PH BALANCER

Available May 2022, our brand new pH balancer is completely designed and manufactured in-house. It is essential for treating wash solutions used for reverse osmosis machines and evaporators. It ensures the neutralization of the pH of the solutions in order to comply with the new environmental standards regarding the discharge of wastewater applicable since 2021, i.e., the Regulation respecting the regulatory scheme applying to activities on the basis of their environmental impact (REAFIE).

It is offered at a very competitive price and its remarkable operating simplicity makes it possible to achieve a result similar to that of more complex to use equipment.



STAINLESS STEEL WASH TANK	CODE
12" x 24" x 36", 29 USG	CN006-122436S3
Sap filter rack (24" tank)	CN427-000002A1
Blue housing rack (24" tank)	CN426-000002A1
12" x 30" x 36", 36 USG	CN006-123036S3
Sap filter rack (30" tank)	CN427-000003A1
Blue housing rack (30" tank)	CN426-000003A1
12" x 36" x 36", 43 USG	CN006-123636S3
Sap filter rack (36" tank)	CN427-000004A1
Blue housing rack (36" tank)	CN426-000004A1
24" x 36" x 36", 84 USG	CN006-243636S3
Sap filter rack (36" tank)	CN427-000004A1
Blue housing rack 70 gal (36" tank)	CN426-000005A1
24" x 48" x 36", 108 USG	CN006-244836S3
18" x 48" x 36", 84 USG	CN006-184836S3
Sap filter rack (48" tank)	CN427-000006A1
Blue housing rack (48" tank)	CN426-000006A1

WASH TANK OPTIONS	CODE
3000 W element	CN415-003000S4
3000 W element and thermostat with stainless steel well	CN005-000001XX
Safety system for heating element (magnetic box and water level control)	CN005-000002S4
Blue box for washing	CN005-000003S4
SS well for temperature control	EL830-010001SS

NEW

MODULAR MEMBRANE VESSEL RACK

This flexible design allows multiple configuration. It can accommodate single or double membrane vessels, multy filtration units, booster pumps and even flowmeters for each membrane. The combination of single and double membranes housing, combined to a booster pump allows a higher concentration while maintaining exceptional performance.

5000 series technology is now available on smaller Lapierre R.O.'s



2500 OR 3500 OPTION

More compact with Horizontal membrane vessels

More compact and requiring less space, our 2500/3500 version is available with the 2000 and 3000 Series R.O.'s. The horizontal configuration of the stainless steel vessels on the rack allows quick and easy handling of the membranes at the beginning and end of the season.

*Not available on the 3 HP model



PRESSURE GAUGES GLYCERINE 2,5"	CODE
0-100 lb SS, connexion 1/4"	DV206-010040S6L
0-100 lb Brass lead free, 1/4"	DV206-010040SPL
0-400 lb connexion, SS 1/4"	DV206-040040S6L
0-600 lb SS, connexion 1/4"	DV206-060040S6L
0-600 lb Brass lead free, 1/4"	DV206-060040SPL
0-30 lbs Brass lead free, 1/4"	DV206-003040SPL
0-1000 lbs Brass lead free, 1/4"	DV206-100040SPL

PRESSURE GAUGES DRY 4"	CODE
0-1000 lb SS, connexion 1/4"	DV264-100072S6L
0-1000 lb Brass lead free, 1/4"	DV206-100040S6L

R.O. BOOSTER PUMP

The booster pump will significantly increase your R.O.'s performance. This pump is installed on the R.O. circuit and is intended to increase operating pressure, total flow rate and Brix level. It is recommended for use on R.O.'s with 3 or more housings. Ask your representative to choose the right model for your machine.

Various capacities are available depending on the quantity of housings: from 2 HP 20 GPM to 10 HP 100 GPM. Sold with variable speed control for optimal pressure adjustment. Please contact your Lapierre representative for more information.

REVERSE OSMOSIS MEMBRANE

4 INCH MEMBRANE	CODE
Filmtec NF90-4040, 4" x 40"	CN009-000440XX
ESPA4-4040, 4" X 40"	CN034-000440XX

STORAGE TANK	CODE
4" x 40"	CN002-000440XX
8" x 40"	CN002-000840NX

8 INCH MEMBRANE (MAX. 800PSI)	CODE
HYDRAPRO 102, 8" X 40"	CN033-000840XX
HB2535, 8" X 40"	CN027-000840XX

8 INCH MEMBRANE (MAX. 600PSI)	CODE
ESPA4, 8" X 40"	CN034-000840XX
MAPLE XLE-8040, 8" X 40"	CN026-000840XX



MEMBRANE CLEANING SERVICE

For more than 35 years, Lapierre Equipment has specialized in post-sugar season servicing of your membranes.

Our cleaning service is available to all customers using membranes, regardless of the make and model of their R.O. We pick up and deliver your membrane.

All products used for washing and storage are approved for use by organic sugar bushes. Since we are always looking to improve our customer service, tests are performed on all membranes sent to us for cleaning:

- **A sugar test before cleaning**
- **A performance test before and after cleaning**

These tests are provided completely free of charge when you send your membrane for cleaning. In addition, we are available for membrane repairs:

- **Damaged fibreglass**
- **Broken or loose plastic washer**

MEMBRANE CLEANING SERVICE	CODE
4" or 8" performance and sugar test	CN401-000000XX
4" performance and sugar test + cleaning	CN401-000401XX
8" performance and sugar test + cleaning	CN401-000801XX



AUTOBRIX VALVE CONTROLLER

The AUTOBRIX valve controller ensures that you get a constant value from the Brix level to your R.O.'s output. Combined with a precise Brix reader, the controller will modulate the opening of the concentrate valve using a highly efficient algorithm.

The constant level of the Brix being targeted optimizes the performance of the evaporator and reduces its consumption and evaporation time. No need for an operator to stand in front of the R.O. constantly to monitor and adjust the opening of the concentrate valve.

- Can be installed on all Lapierre R.O. models as well as all other manufacturers' models;
- Stable and accurate Brix level at the R.O. outlet;
- The AUTOBRIX valve controller can accept data from most Brix drives continuously.

AUTOBRIX VALVE WITHOUT MOUNTING ON CABINET	CODE
AutoBrix valve 3/8" compression low flow	CN175-000406CX
AutoBrix valve 3/8" compression high flow	CN175-000606CX

MOUNTING FOR AUTOBRIX VALVE LOW OR HIGH FLOW	CODE
On cabinet on R.O. 2000, 3000 & 3500	CN375-300006KT
On cabinet on R.O. 5000	CN375-500006KT

BRIX READER ON SUPPORT	CODE
Continuous Brix reader 0-33 for mounting on standard 2000, 3000 & 3500 R.O.	DV175-300033KT
Continuous Brix reader 0-33 for mounting on standard 5000 R.O.	DV175-500033KT
Continuous Brix reader 0-45 Lapierre for mounting on standard 2000, 3000 & 3500 R.O.	CN075-300045KT
Continuous Brix reader 0-45 Lapierre for mounting on standard 5000 R.O.	CN075-500045KT
Continuous Brix reader 0-80 for mounting on standard 2000, 3000 & 3500 R.O.	DV176-300080KT
Continuous Brix reader 0-80 for mounting on standard 5000 R.O.	DV176-500080KT

REMOTE CONTROL OPTION ON R.O.	CODE
AutoBrix valve & Brix reader not included	CN371-000001XX



LAPIERRE BRIX READER 0-45



BRIX READER 0-33



BRIX READER 0-80

EVAPORATORS CONFIGURED FOR 50/50 MORE SYRUP AND MORE FLAVOUR!

OPTIMAL CONFIGURATION FOR A 15 to 30 BRIX CONCENTRATION

Impressively easy to use, the 50/50 configuration evaporators have flat pans of equivalent length to the surface of the flue or tube pans. The optimum configuration to enhance flavour development while saving fuel.

The 50/50 configuration evaporators, combined with a Lapierre R.O., enable a concentrate to evaporate from 15 to 30 Brix, thus allowing a greater amount of syrup to be produced per hour. The ideal choice for medium and large sugar bushes.

The 50/50 configuration is available on our Turbo 3 and Volcano 2000 Series oil fired evaporator as well as on the Force 5 and Fusion wood fired evaporator. Several sizes are available. Ask your maple syrup advisor for more information.

Results of tests carried out with producers in spring 2020

- Equipment: Turbo 3 6' x 20'
- Concentrated: 23,5 Brix
- Average oil consumption:
0.15 gallons per 1 gallon of syrup
- Average production: 211 imperial gallons or
253 us gallons per hour



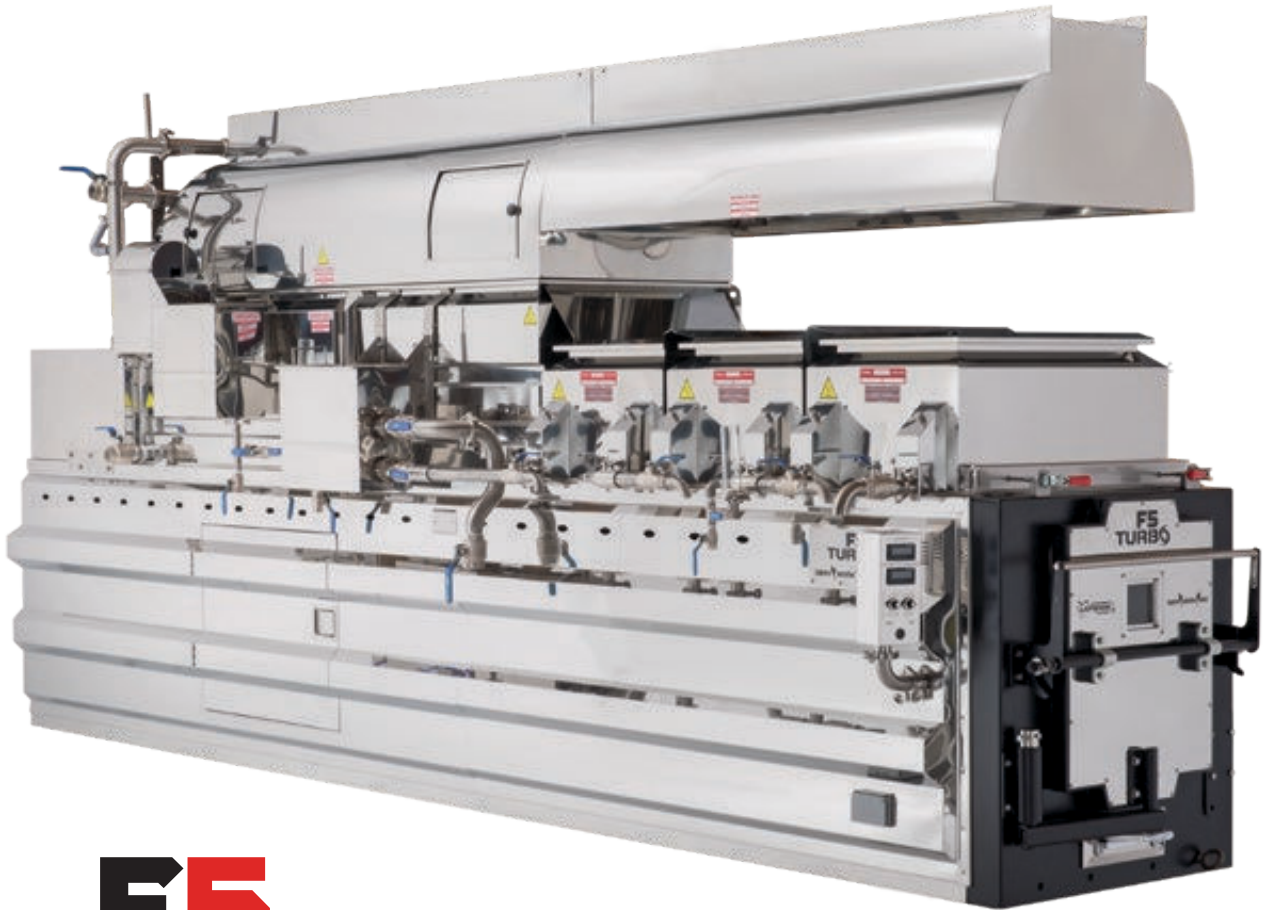

F5 TURBO

The Force 5 TURBO is the fusion between the best combustion controlled FIRED wood arch and the Lapierre-Waterloo-Small designed fire tube double pass Turbo pan. A combination that makes evaporating with wood FUEL even more efficient and economical!

OFFERED FROM

- 2 1/2' x 8' to 6' x 18'

SUPER HEAVY DUTY CONSTRUCTION		
Syrup pan	Ends	20 ga
	Sides	22 ga
Flue pan	Walls	18 ga
	Flues	22 ga
Hood	Ends	20 ga
	Sides	22 ga



Super heavy duty arch frame structure.



THE WOOD COMBUSTION REFERENCE IS GETTING BETTER ALL THE TIME

- The Force 5 has a unique heat exchanger system;
- No smoke, soot or creosote;
- No sparks or embers out of the stack;
- Wood is the least expensive combustible available;
- Excellent insulation (no heat loss on the sides);
- Heat is spreaded uniformly to eliminate hot spots;
- No hot spots means less niter build up;
- Complete control of evaporation intensity.
- Optiflam option available

ELECTRICAL SYSTEM ENTIRELY CERTIFIED!

Eliminate safety authorities issues and insurance concerns.



Reloading is noticeably far apart with Force 5 controlled arch (will vary according to producer reality).



Optionnal Door Model

OFFERED FROM

- 2 1/2' x 8' to 6' x 18'

Ask your Lapierre representative to help you determine the right equipment size for your needs.

Standard Features

- Door is covered with stainless steel on the outside and insulated with high temperature ceramic wool on the inside;
- Clean out doors front and rear;
- Control cabinet can be positioned on either side of the arch;
- Metallic ducts are used for wiring for total protection;
- Factory installed high temperature brick and insulation.

The Force 5 is ready to use!



SUPER HEAVY DUTY CONSTRUCTION		
Syrup pan	Ends	20 ga
	Sides	22 ga
Flue pan	Walls	18 ga
	Flues	22 ga
Hood	Ends	20 ga
	Sides	22 ga

Super heavy duty arch frame structure.

Force 5 reaches very high furnace temperatures while maintaining low exhaust values, demonstrating how efficiently it uses energy.

Force 5 users are pleased with how the heat distribution and its intensity under the pans enhances maple flavor.



HYPERBRIX® version available

The Force 5 is also able of handling 35 Brix concentrate for fuel economy at its best and make syrup with genuine maple flavor.

FUSION X²

WOOD FIRED EVAPORATOR

IGNITE THE POWER OF NATURE



FUSION X²

A BEAST WITH A GREAT DESIGN

A new high-performance grind based on an ingenious design using the proven technologies of our range of wood-fired Hurricane evaporators. A perfect blend of power and performance for a greater volume of quality syrup.

The FUSION X2 offers above all an improved design, such as the walls of the combustion chamber for more efficient thermal performance. A variable speed air injection and diffusion system provides high operating stability as well as constant uniformity in thermal transfer.

- Available from 2 1/2' x 8' to 6' x 16'
- Available in 50/50 configuration

THE FUSION OF INNOVATION COMBINING PERFORMANCE AND NATURE

BENEFITS

- Very high evaporation performance
- Thermal efficiency and fuel economy
- Ease of operation in the range of 1300 to 1900°F
- More eco-friendly due to its high-performance combustion chamber
- Large combustion chamber capacity, over 300 lbs. of dry wood

SPECIFICATIONS

- Variable speed fan control
- Temperature sensor set and digital display
- Loading door: stainless steel exterior cladding and high temperature ceramic wool insulation
- Factory-installed fire brick and refractory cement furnace
- Preheated air supply for fuel savings



OPTIFLAM combustion controller option for easier operation, performance and increased savings.

OUR CLASSIC OIL EVAPORATOR: THE VOLCANO 2000



The Volcano 2000 is one of a kind, it is a machine made with the highest quality standards.

All controls and instruments are easily accessible in the front panel.

The low profile of the furnace allows you to see what is happening inside your syrup pans.

Available with Riello variable intensity or Carlin burners.

OFFERED FROM

- 2 1/2' x 8' to 6' x 16'

SPECIFICATIONS

- Exterior is completely 304 stainless steel;
- Control switch (high+low), fire on 701 and 801 burners;
- Oil pressure gauge;
- Key type ignition for start up, with security lock;
- In-operation hour meter;
- Port hole allows you to see the flame;
- Junction box allows for a quick and easy hook up of the burners;
- Insulated burner cover to reduce noise;
- Electric plug for thermoregulator and other uses;
- Propane and natural gaz also available.



VOLCANO 2000 **HYPER BRIX** EVAPORATION

The HYPERBRIX® Volcano 2000 is configured to be efficient and economical boiling 35 Brix concentrate. Maple syrup taste is also prioritized by a design that features greater flat pan surface.



The Lapierre-Waterloo-Small HYPERBRIX® VOLCANO 2000 evaporators are available with a complete range of modulating Riello oil and gas burners. Burner modulations allow heat release control to be adapted to the maple concentrate condition.

RIELLO Features

- High energy efficiency;
- Unique flame pattern;
- Heat can vary from 20 % to 100 %;
- Environment oriented european technology;
- The most economical burner on the market;
- Propane and natural gaz also available.

USES LESS THAN **1/7** GALLON OF OIL TO MAKE ONE GALLON OF SYRUP

(AT 24 BRIX)

OFFERED FROM

- 2 1/2' X 12' to 6' X 20'

A SUPERIOR EVAPORATION CAPACITY WITH LESS FUEL, FEATURING:

- Double pass for much greater heat transfer under the tube pan;
- Fire tubes are 30% bigger for extreme heat absorption by the pans;
- Slows gas flow for better heat transfer resulting in superior evaporation rate;
- 4 finishing pans design for high concentration and flavour enhancement;
- Fully adjustable boiling intensity;
- Silent operation.

TURBO
Génération **3**

Impressive oil economy is achieved when a Piggy-Back Turbo steam pan is used in conjunction with the Turbo 3.



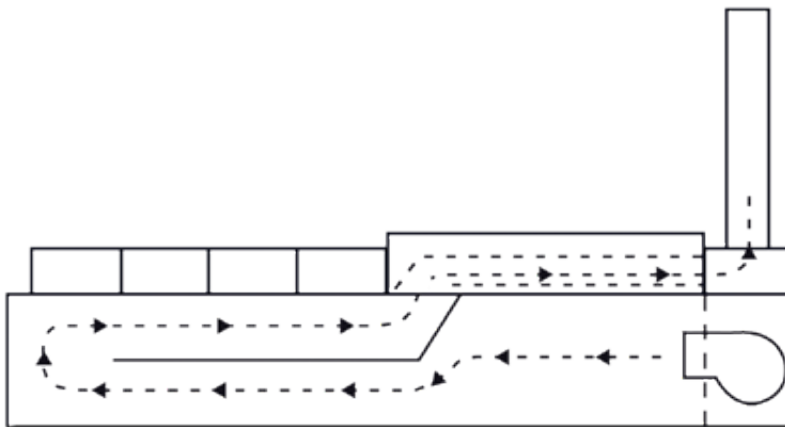

9" fire tubes for optimal performance and greater heat transfer

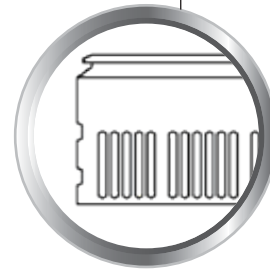

SUPER HEAVY DUTY PAN CONSTRUCTION

Syrup pan	Ends	20 ga
	Sides	22 ga
Tube pan	Walls	18 ga
	Tubes	22 ga
Hood	Ends	20 ga
	Sides	22 ga

Optional RIELLO burners

The TURBO 3rd Generation evaporators are available with modulating RIELLO burners. Burner modulations allow heat release control to be adapted to the maple concentrate condition.

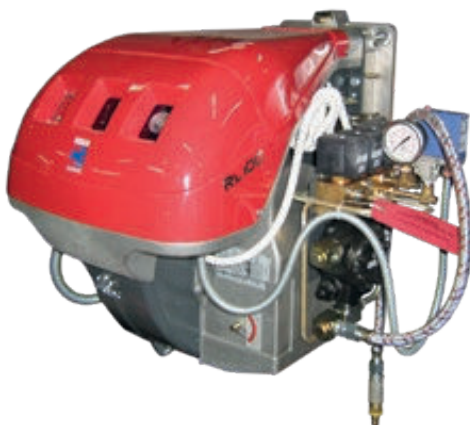

RIELLO Features

- High energy efficiency;
- Unique flame pattern;
- Heat can vary from 20 % to 100 %;
- Environment oriented european technology;
- The most economical burner on the market;
- Propane and natural gaz also available

VISION

Fire and performance for hobby and small business operations.



WOOD FIRED EVAPORATORS **EXCEPTIONAL VISION**



VISION

EXCEPTIONAL VISION

This line of evaporators offers you exceptional vision:

- With a full size airtight door and air cooled for a better efficiency
- Of the inside of the arch for an unprecedented feel in your *Sugar Shack*
- With its classic, sleek design and state-of-the-art technology
- Thanks to its newly-engineered combustion chamber

Our VISION line is designed for hobby or smaller sugar makers or those without electricity. It offers producers high performance, high efficiency and amazing ease of operation.

PRACTICAL FEATURES FOR AN INFORMED DECISION:

- Enclosed ash box allows for installation on any surface
- Adjustable legs for multiple height options and ease of leveling
- “Comfortable” working height, even for small models
- Single door giving access to the arch and ash box
- Stainless steel ultra-chic design
- Easy to clean
- Cooled arch door handle

VISION 18 & 24 in EVAPORATORS WITH INNOVATIVE DRAW-OFF PANS:

- Perfect for beginners and intermediates
- Remarkable boiling distribution
- One single control level - or float - rather than two



OUR NEW AIRTIGHT COMBUSTION CHAMBER IS THE CORE OF OUR PERFORMANCE

Large arch capacity:

- Reduces the number of refills per hour

Airtightness achieved by:

- With fully gasketed door as well as gasketing between the arch and pans.
- An optional seal between each pan

Airtightness for:

- Faster start-up
- Better burn rate control
- Less cold air ingress for increased performance
- Performance equal to or better than current models of the same capacity
- Less fuel

Energy efficient to:

- Significantly reduce heat loss and energy consumption
- Optimize the amount of energy used for syrup production

Choice of lines:

The VISION line offers you several possibilities regarding the equipment included with your evaporator.

From the basic model to the top of the line, each of them has what it takes to produce high quality maple syrup.

Dimensions :

18 x 48 in*	30 x 120 in	36 x 120 in	36 x 144 in
18 x 60 in*			
24 x 72 in*			
24 x 96 in			
24 x 120 in			

Patent pending



Warranty

Two-year limited warranty on parts and labor

*Available dimensions for innovative draw-off pans.
*Dimension disponible avec panes à bouillir innovantes



Picture shows
2' x 6'

The Classic

AVAILABLE SIZES

- 2' x 6'
- 2' x 8'
- 2' x 10'

AVAILABLE OPTION

- Pan covers.

A high efficiency evaporator with a 7" deep raised flue pan but assembled with basic plumbing connections (similar to the Junior model). There is only one pan in the front with two partitions (three compartments) going width wise and return connection boxes on opposite corners. This model will give you the same boiling rate per hour compare to our Storm model but for less money.

SPECIFICATIONS

- 7" raised flues;
- Arch: cast iron front, galvanized steel or stainless sides;
- 20 g. walls, 22 g. flues #304 stainless;
- Smoke stack included (2 x length of the evaporator including base pipe);
- Cold and hot float boxes;
- Stainless heavy duty interconnections;
- Draw off ball valve included;
- Fire bricks and insulation kit not included.

The Barrel



These hobby evaporators with a flat bottom pan are designed for those who want to have fun while making maple syrup for their own use. Less efficient compared to a larger evaporator, we recommend using a finisher.

AVAILABLE SIZES

- 24" x 36" (20 to 50 taps)

SPECIFICATIONS

- 22 g. #304 stainless flat bottom pan, 3 compartments;
- Arch: 16 gauge steel;
- Includes 90 deg 6" elbow for chimney;
- #304 stainless pre-heater pan, 9" x 22";
- 3/4" draw off ball valve included;
- Fire bricks not included.



Propane Evaporator

AVAILABLE SIZES

- 16" x 48" (10 to 30 taps)

SPECIFICATIONS

- Gas stove with three 65 000 BTU burners;
- 16" x 32" flue pan (4" flues) with float box;
- 16" x 16" syrup pan with float box;
- Propane tank not included (For outside use only).

Propane Finisher



AVAILABLE SIZES

- 16" x 48"

SPECIFICATIONS

- 3- 16" X 16" Propane stoves of 65,000 BTU each maximum;
- 1-Stainless steel finishing pan with flat bottom 16" X 48" X 14" High, no partition;
- 3/4" ball valve with elbow included;
- NO float box;
- Propane tanks not included (For outside use only).

High Pressure Pan Washer

The natural solution to save time and cleaning products

This system provides continuous, non-contact washing to remove stubborn stains

- For both flue and syrup pans
- 5 HP recirculation pump
- Entirely made of stainless steel
- 4 or 5 Belimo valves depending on the size of the evaporator
- Use in automated and sequential mode or in manual mode
- Up to 5 programmable washing sequences
- Tank with filtration screen, splash-proof Lexan and non-slip metal plate used as a step

SYRUP PAN OPTION

Stainless steel tube with nozzles that can remain in place during operation.
 Splash proof Lexan cover

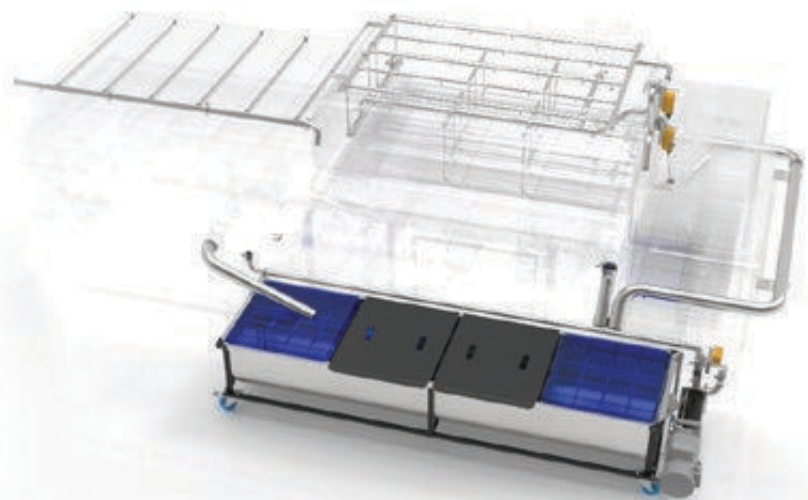

Recessed covers with sprinklers

(Lapierre syrup pan)

Available from 2 to 9 sprinklers for syrup pans 18" x 36" up to 72" x 72"

For pans other than Lapierre, you must provide internal dimensions and contact us for details

PAN WASHERS FOR RECESSED COVERS WITH SPRINKLERS	CODE
Complete pan washer 24" reservoir	EV051-000024XX
Complete pan washer 48" reservoir	EV052-000048XX
Complete pan washer 72" reservoir	EV053-000072XX

All tanks include 1 Goulds pump and 1 filter:
 For 24" and 48" tanks = 1/2 HP pump;
 For 72" tank = 1 HP pump.
 Cover not included.



RECESSED COVER WITH SPRINKLERS (LAPIERRE PAN)	CODE
Cover 2 sprinklers for pan 30" x 18"	EV050-023018XX
Cover 2 sprinklers for pan 36" x 18"	EV050-023618XX
Cover 2 sprinklers for pan 36" x 20"	EV050-023620XX
Cover 2 sprinklers for pan 36" x 24"	EV050-023624XX
Cover 2 sprinklers for pan 42" x 18"	EV050-024218XX
Cover 2 sprinklers for pan 42" x 20"	EV050-024220XX
Cover 2 sprinklers for pan 42" x 24"	EV050-024224XX
Cover 2 sprinklers for pan 48" x 20"	EV050-024820XX
Cover 2 sprinklers for pan 48" x 24"	EV050-024824XX
Cover 3 sprinklers for pan 60" x 18"	EV050-036018XX
Cover 3 sprinklers for pan 60" x 24"	EV050-036024XX
Cover 3 sprinklers for pan 72" x 24"	EV050-037224XX
Cover 4 sprinklers for pan 48" x 48"	EV050-044848XX
Cover 6 sprinklers for pan 48" x 72"	EV050-064872XX
Cover 6 sprinklers for pan 60" x 48"	EV050-066048XX
Cover 6 sprinklers for pan 72" x 48"	EV050-067248XX
Cover 9 sprinklers for pan 60" x 60"	EV050-096060XX
Cover 9 sprinklers for pan 72" x 72"	EV050-097272XX

OPTIONS	CODE
Auto-Stop by pressure	EL049-281102XX
Stainless steel sprinkler only with acetal adaptor	EV250-000000XX
Filter only 1 1/2"	EV250-000002XX
Filter only 2"	EV250-320002XX

TURBO STEAM-PAN: Piggy Back

EFFECTIVE AND ECONOMICAL TECHNOLOGY

AVAILABLE SIZES

- 3' x 9'
- 3' x 10'
- 3 1/2' x 9'
- 3 1/2' x 10'
- 4' x 9'
- 4' x 10'
- 5' x 9'
- 5' x 10'
- 6' x 10'

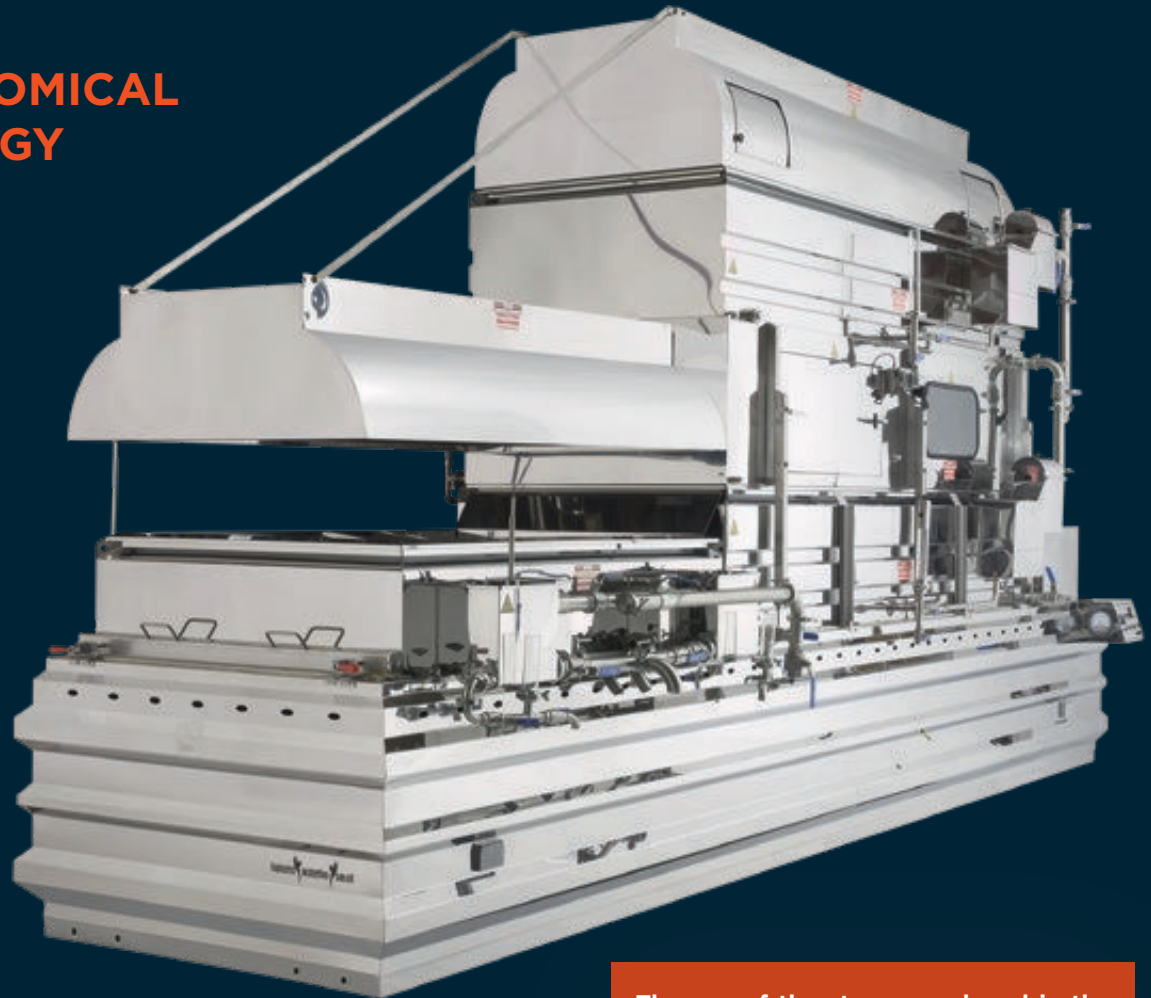

The use of the steam produced in the evaporation process in an excellent way to reduce your energy costs by up to 40%.

More than 30 years ago, the Piggy Back was introduced to help maple producers save time, energy and space. Lapierre Equipment is proud to present to you the latest innovation with focus on improved efficiency and ease of cleaning. The TURBO tube pan design allows even greater energy transfer for enhanced performance. The TURBO steam pan can increase your evaporator performance by up to 40%.

If you are looking for ultimate performance and economy in evaporation you should be looking at our Piggy Back steam pan. At 24 Brix it only consumes 1/10 gallon of oil per gallon of syrup with our TURBO fire tube evaporator.

Available for all Lapierre-Waterloo-Small evaporators models
(more than 3')

Please contact your representative for more details.

REVERSE FLOW KIT

Allows you to draw syrup all day without changing your cross flow pans.

Fits wood or oil evaporators. Includes: ball valves and fittings to connect "HOT" float box to rear and front inlets. You will be ready to draw syrup in less than 5 minutes (requires 3 to 4 syrup pan configuration). Optional: all stainless steel ball valves.

CENTRAL DRAW-OFF KIT

Allows you to draw syrup without moving the syrup tank when using the draw-off inversion kit.

2" SIGHT LEVEL

This sight level makes reading much easier and accurate than ever before. Available for syrup and flue pans.

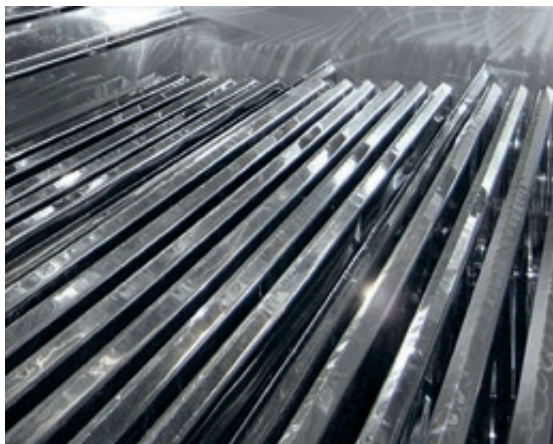

7" AND 9" HIGH DIAMOND POINT FLUES

Made with 304BA (Bright annealed) SS and available on Hurricane Force 5 and Fusion, Volcano and Volcano 2000, the new diamond point flues will make your flue pan easier to clean.



DIRECT ACTION FLOAT BOXES

Direct action float boxes for accurate and fast sap transfer and precise pan level control.



6 COMPARTMENT SYRUP PAN WITH BUILT IN REVERSE FLOW KIT AND CENTRAL DRAW-OFF KIT

This pan evaporator by replacing 3 to 4 syrup pans, by saving on stainless and insulation.

The central draw-off allows you to draw syrup without moving the syrup tank when using the draw-off inversion kit.

SAFETY,
it's a family affair!

**NOW OFFERING
HIGH QUALITY
CHIMNEY
SOLUTIONS**

**DID YOU KNOW THAT
A **FAULTY CHIMNEY** INSTALLATION
MAY CAUSE A FIRE?**

Your single wall chimney must;

- Provide 24 inches clearance to a combustible wall.
- Provide 18 inches clearances to any combustible material.
- Stack termination must be 10ft higher than any obstacle in a 20ft radius.

**LAPIERRE EQUIPMENTS IS NOW OFFERING
A **DOUBLE WALL INSULATED LISTED CHIMNEY****

- UL103HT listed chimney.
- Specifically designed for the Maple Industry.
- Needs only 2 inches clearance to any combustible material.
- Must be 3ft above any obstacle in a 10ft radius (therefore permitting shorter run, saving cost).
- Allow the use of a smaller diameter chimney for the same evaporator, (saving cost).
- RECOGNIZED BY YOUR INSURANCE COMPANY.



CHIMNEY PIPE PREFAB

CODE	DIAMÈTRE	HAUTEUR
CH008-061200LW	6"	12"
CH008-061800LW	6"	18"
CH008-062400LW	6"	24"
CH008-064800LW	6"	48"
CH008-081200LW	8"	12"
CH008-081800LW	8"	18"
CH008-082400LW	8"	24"
CH008-084800LW	8"	48"
CH008-101200LW	10"	12"
CH008-101800LW	10"	18"
CH008-102400LW	10"	24"
CH008-104800LW	10"	48"
CH008-121200LW	12"	12"
CH008-121800LW	12"	18"
CH008-122400LW	12"	24"
CH008-124800LW	12"	48"
CH008-141200LW	14"	12"
CH008-141800LW	14"	18"
CH008-142400LW	14"	24"
CH008-144800LW	14"	48"
CH008-161200LW	16"	12"
CH008-161800LW	16"	18"
CH008-162400LW	16"	24"
CH008-164800LW	16"	48"
CH008-181200LW	18"	12"
CH008-181800LW	18"	18"
CH008-182400LW	18"	24"
CH008-184800LW	18"	48"
CH008-201200LW	20"	12"
CH008-201800LW	20"	18"
CH008-202400LW	20"	24"
CH008-204800LW	20"	48"
CH008-221200LW	22"	12"
CH008-221800LW	22"	18"
CH008-222400LW	22"	24"
CH008-224800LW	22"	48"
CH008-241200LW	24"	12"
CH008-241800LW	24"	18"
CH008-242400LW	24"	24"
CH008-244800LW	24"	48"

PARTS BELOW ARE INCLUDED WITH THE PURCHASE OF AN EVAPORATOR*
Chimney sold separately

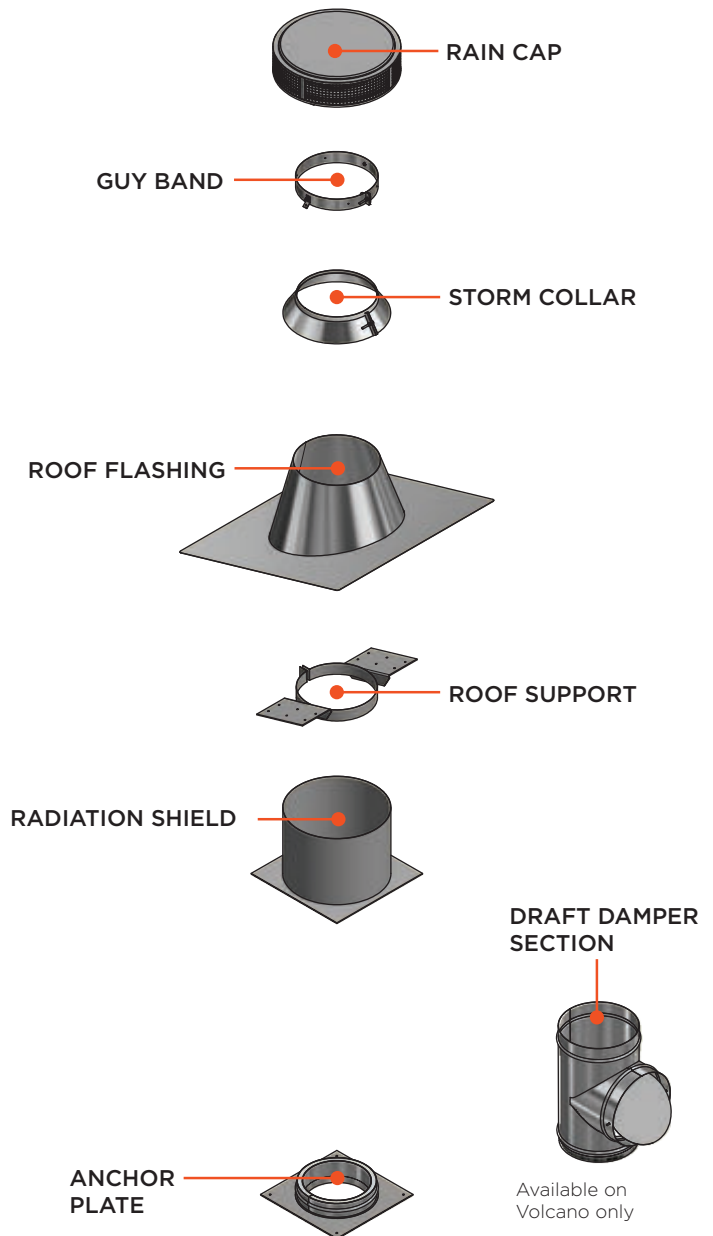

An extensive line of products is available. For information, contact your Lapierre dealer.

*Optional on wood fired evaporator without fan.

MAPLE SYRUP AUTO CONTROL

- Made by Lapierre;
- High precision;
- Fast reaction and reliable;
- Removable actuator and control box;
- Programmable to adapt to evaporator size;
- Easy to wash;
- Manual or auto mode;
- Probe included;
- Heavy duty SS clamp and gasket required.

SEE PAGE 107



**LAPIERRE
EXCLUSIVE**

LAPIERRE MODULATING DRAW-OFF	CODE
Ferrule 1 1/2" outlet (1 probe)	DV122-240001XX
Ferrule 1 1/2" outlet (2 probes)	DV122-240002XX
1 1/2" replacement rubber gasket	DV322-000024Q1
Elbow, 90°, 1 1/2" (optional)	EV707-902424S2
Ferrule 2" outlet (1 probe)	DV122-000001XX
Ferrule 2" outlet (2 probes)	DV122-000002XX
2" replacement rubber gasket	DV322-000032Q1
Elbow, 90°, 2" (optional)	EV707-903232S2

A - DISPENSER AUTO	CODE
For liquid de-foamer	DV168-000000XX
Replacement pump	PM568-240104XX

B - SONDE SUPPORT	CODE
Sonde support for front pan	CS015-031303ST

C - SS ROPE OPERATED STACK COVER
Available for smoke stack and steam stack in all sizes. Price upon request

D - PEAK STYLE COVER
For steam stack in all sizes. Price upon request

A



B

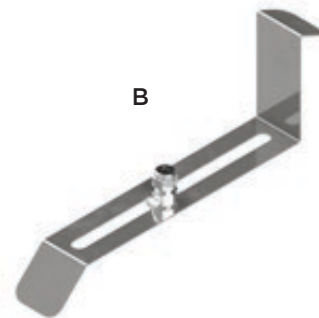

C



D





A



B



C



D



E



F



G



H



I



J

MISCELLANEOUS	CODE
A - 8 1/4" digital thermometer	EITB0012
B - 12" SS back thermometer	EITDT158
C - 18" thermometer	EITBC018
Replacement stem for 18" thermometer	EITRC018
D - 5" barometer	DV010-001353XX
E - Maple syrup digital grader HI759	DV024-000759XX
F - Lovibond Comparator (New grading system)	DV034-433240XX

CENTRE ACER	CODE
G - Maple syrup off-flavor detection kit	DV039-000000XX
H - Grading kit of IISE/IMS for new classification	DV028-000000XX
I - 1 oz simple bottle	EICOL016
Syrup grading kit VT 2019	EICOL001

J - DIAL THERMOMETER	CODE
3" dial 1/4" thread, 6" stem 0-50 deg. F	EITC0306
3" dial 1/4" thread, 9" stem 0-50 deg. F	EITC0309
3" dial 1/4" thread, 12" stem 0-50 deg. F	EITC0312
5" dial 1/4" thread, 9" stem 0-50 deg. F	EITC0509
5" dial 1/2" thread, 9" stem 0-50 deg. F	EITC5509
3" dial 1/2" thread, 9" stem 0-250 deg. F	EITC0325
3" dial 1/2" thread, 6" stem 50-300 deg. F	EITC0336
3" dial 1/2" thread, 9" stem 50-300 deg. F	EITC0330
3" dial 1/2" thread, 18" stem 50-300 deg. F	EITC0318
5" dial 1/2" thread, 12" stem 50-300 deg. F	EITC0512
3" dial 1/2" thread, 2 1/2" stem 200-1000 deg. F	DV267-084048XX
3" dial 1/2" thread, 4" stem 200-1000 deg. F	DV267-086448XX



OPTIFLAM^{MD}
combustion controller



COMBUSTION CONTROL SYSTEM

ASSISTED PERFORMANCE

CONTROLLER	CODE
Optiflam automated combustion controller	FF200-000001XX

FOR OPTIMAL EFFICIENCY & MINIMAL WOOD CONSUMPTION

OPTIFLAM is an automated system for supporting the thermodynamic properties of the evaporator combustion chamber to optimize heat using a minimum amount of fuel.

- Measures various operating conditions to determine the best evaporator operating conditions.
- Adjusts fan speed continuously to maintain the temperature set by the operator.

BENEFITS

- The OPTIFLAM provides automated operation of your evaporator in order to maintain optimal and constant heat without any need for assistance on your part.
- The operator's only involvement is putting wood into the combustion chamber when indicated on the display.
- This minimizes flow interruptions and improves syrup quality.
- Allows control over the amount of fuel used.

**INTEGRATES WITH LAPIERRE FORCED AIR - WOOD FIRED EVAPORATOR
ON EXISTING OR BRAND NEW DEVICES**

TOUCH SCREEN DISPLAY

OPTIFLAM is equipped with an easy-to-use 7.5 inch (19.5 cm) touch screen to access the various functions of the combustion manager.

Combustion statistics on the evaporator combustion settings are compiled and displayed on the screen:

- The operating time.
- The average temperature maintained.
- The time between reloads
- The time required to recharge.
- Temperature set by the operator.

3 OPERATING MODES

AUTOMATIC MODE

OPTIFLAM takes care of the evaporator. Adjusts fan speeds, gives wood reload warning, monitors combustion and stops fan operation at the end of production.

MANUAL MODE

The operator controls the fan speed directly, as with a standard Hurricane, but from the control screen.

MECHANICAL MODE

The operator controls the fan speed directly, as with a standard Hurricane, using rheostats, but from the control box.



ATAGO	CODE
Master H series 60-70 brix (syrup)	DV012-006070XX

Developed especially for maple syrup

- 60 to 70 Brix scale easier than ever to read;
- No need to cool down syrup before testing;
- Built-in protection against dust and water.



A



B



DIGITAL REFRACTOMETER	CODE
A - Atago digital 0-85 Brix	DV013-000085XX
B - Misco digital 0-85 Brix	DV022-000085XX

REFRACTOMETER	CODE
LED backlit 0-32 Brix (sap and high concentrate)	DV014-000032XX
LED backlit 45-82 Brix (syrup)	DV014-004582XX



CENTRE ACER	CODE
Calibration solution 66.0 brix (for refractometer)	DV137-000660XX



Hydrometer and hydrotherm



Conductivimeter

HYDROMETER AND HYDROTHERM	CODE
USA certified hydrometer 0-12 Brix (sap) (USA only)	DV020-000012VT
USA certified hydrometer 45-75 Brix (syrup) (USA only)	DV020-004575VT
Hydrometer 0-35 Brix (sap)	DV020-000035XX
Hydrometer 45-75 Brix (syrup)	DV020-004575XX
Robi density for hydrotherm (1 liter)	DV426-000001XX
Hydrometer 0-15 Brix (sap)	DV020-000015XX
Hydrometer 50-70 Brix (syrup)	DV020-005070XX
Hydrotherm red column	DV023-000000XX
Conductivimeter Hanna HI98308 (5 programmable scale)	DV021-098308XX



HYDROMETER AND HYDROTHERM CUP	CODE
Hydrometer cup 1 1/2" x 14" WITH BASE	DV025-002414ST
Hydrotherme cup 2" x 12" WITHOUT BASE	DV025-003212ST
Hydrotherme CUP 2" x 14" WITHOUT BASE	DV025-003214ST



SS BUTTERFLY VALVE (BLACK HANDLE)	CODE
1 1/2"	VA020-002424S2
1 1/2" rubber gasket	VA020-000024Q1
2"	VA020-003232S2
2" rubber gasket	VA020-000032Q1

SANITARY TRI-CLAMP REPLACEMENT CLEAR GASKET	CODE
1"	EAG40MP-S10
1 1/2"	EAG40MP-S15
2"	EAG40MP-S20
3"	EAG40MP-S30



SS FERRULE CLAMP WITH SCREW	CODE
1 1/2"	DV256-000024S2
2"	DV256-000032S2
3"	DV256-000048S2
4"	DV256-000064S2

CERAMIC BLANKET	CODE
12" x 24"	DV475-162408XX

HIGH DENSITY ARCH BOARD	CODE
24" x 48" x 1/2"	EBISOL24

ARCH TO PAN GASKET	CODE
1 1/2" x 3/8"	EBTPR021
2" x 3/8"	EBTPR122

FIRE BRICK AND REFRACTORY CEMENT	CODE
1 1/4" Brick	DV477-010904XX
2 1/4" Brick	DV477-020904XX
Refractory cement (15 lb)	DV476-000016XX
Refractory cement (25 kg)	DV476-000025XX



FILTER	CODE
#8 filtration cone	EVBO008W
#8 filtration cone seamless	EVBF008W
#8 poly. prefilter, 12/pack	EVPAT008
Filtration material 36" x 36"	EVCO3636
Polyester paper 36" x 36", 12/pack	EVPA3636



DEFOAMER	CODE
Kasher defoamer (200 g)	DV406-000200LA
Liquid defoamer LWS (8 oz)	EVAN108W
Liquid defoamer LWS (32 oz)	EVAM032W
Liquid defoamer LWS (128 oz)	EVAM128W



DEFOAMER CUP (LAPIERRE)	CODE
Defoamer cup 1"	DV045-000001S2
Defoamer cup 1 1/2"	DV045-000002S2



SUNFLOWER OIL	CODE
Deodorized organic sunflower oil (750 ml)	DV508-000750XX
Organic sunflower oil SOLEIL D'OR (3 liters)	DV507-000003XX

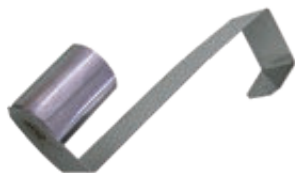

BIO SUNFLOWER OIL, ODORLESS, CERTIFIED KOSHER & ECOCERT	CODE
1 liter	DV509-000001XX
4 liters	DV509-000004XX

DEFOAMER CUP (WATERLOO)	CODE
1" with 4" folded support	EVAMGO01
1" with 10" unfolded support	EVAMGO10
2" with 10" unfolded support	EVAMGO20



SCOOP	CODE
Small scoop	DV040-042003ST
Large scoop	DV040-062001ST
Small perforated scoop	DV041-042004ST
Large perforated scoop	DV041-062002ST



DIPPER	CODE
Round dipper (1 quart)	EADPR030
Round dipper (2 quarts)	EADPR031
Flat side dipper (1 quart)	EADPD040
Round dipper with holes for taffy (2 quarts)	EADPRT31
Flat nose dipper (2 quarts)	EADPD060



ALUMINUM STEP	CODE
22" x 15" x 12"	DV545-221512XX
48" x 15" x 12"	DV545-481512XX



MIXING PADDLE STAINLESS	CODE
6" x 48"	DV052-8067633XX
6" x 60"	DV052-8067634XX



SYRUP PITCHER	CODE
1.5L with spout	AO006-000001ST





ROUND SYRUP FILTER TANK WITH TOP LID	CODE
5 gal (9" dia. x 22" height)	EM115-092205ST
15 gal (14" dia. x 27" height)	EM115-142715ST
24 gal (18" dia. x 27" height)	EM115-182724ST
40 gal (23" dia. x 27" height)	EM115-232740ST
Base on casters for 15-24-40 gal	EM315-010000ST



Cover optional

DUAL SQUARE TANKS ON CASTERS WITH VALVE				CODE
18" x 18" x 32"	2 x 27 imp. gal	2 x 32 USG	21" x 39" x 32" (Overall)	EM160-181832S3
18" x 24" x 32"	2 x 35 imp. gal	2 x 42 USG	21" x 51" x 32" (Overall)	EM160-182432S3
18" x 36" x 32"	2 x 53 imp. gal	2 x 63 USG	21" x 75" x 32" (Overall)	EM160-183632S3
24" x 24" x 32"	2 x 50 imp. gal	2 x 60 USG	27" x 51" x 32" (Overall)	EM160-242432S3
24" x 36" x 32"	2 x 75 imp. gal	2 x 90 USG	27" x 75" x 32" (Overall)	EM160-243632S3

TRIPLE SQUARE TANKS ON CASTERS WITH VALVE				CODE
18" x 18" x 32"	3 x 27 imp. gal	3 x 32 USG	21" x 57" x 32" (Overall)	EM161-181832S3
18" x 24" x 32"	3 x 35 imp. gal	3 x 42 USG	21" x 75" x 32" (Overall)	EM161-182432S3
24" x 24" x 32"	3 x 50 imp. gal	3 x 60 USG	27" x 75" x 32" (Overall)	EM161-242432S3

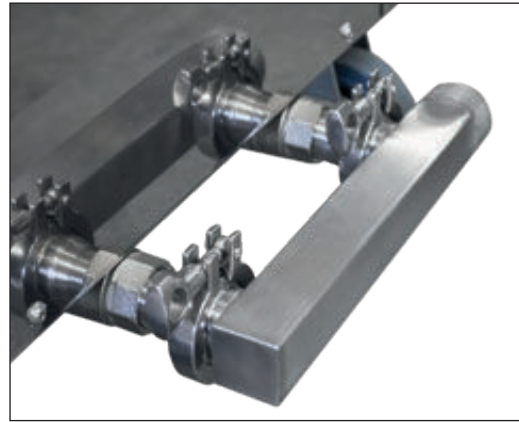

SYRUP TANK WITH CONE FILTERS	CODE
Rectangular syrup tank (24 gallons) with cover and support for three cone filters (#8 cone filters not included)	EM174-122436S3

OPTIONS FOR SQUARE TANKS ON CASTERS	CODE
SS outlet option 1" x 1" x 1 1/4" (MPT x MPT x FPT)	EM360-161620S2
SS outlet option 1" x 1" x 1" x 1 1/4" (MPT x MPT x MPT x FPT) for triple tanks on casters	EM361-161620S2
SS cover with handle (18" x 18")	EM359-001818S3
SS cover with handle (18" x 24")	EM359-001824S3
SS cover with handle (18" x 36")	EM359-001836S3
SS cover with handle (24" x 24")	EM359-002424S3
SS cover with handle (24" x 30")	EM359-002430S3
SS cover with handle (24" x 36")	EM359-002436S3



Stainless steel outlet optional

DUAL SQUARE TANKS ON CASTERS WITH VALVE AND SKIRT				CODE
18" x 18" x 32"	2 x 27 mp. gal.	2 x 32 USG	21" x 39" x 32" (Overall)	EM170-181832S3
18" x 24" x 32"	2 x 35 mp. gal.	2 x 38 USG	21" x 51" x 32" (Overall)	EM170-182432S3
18" x 36" x 32"	2 x 53 mp. gal.	2 x 63 USG	21" x 75" x 32" (Overall)	EM170-183632S3
24" x 24" x 32"	2 x 50 mp. gal.	2 x 60 USG	27" x 51" x 32" (Overall)	EM170-242432S3
24" x 36" x 32"	2 x 75 mp. gal.	2 x 90 USG	27" x 75" x 32" (Overall)	EM170-243632S3

TRIPLE SQUARE TANKS ON CASTERS WITH VALVE AND SKIRT				CODE
18" x 18" x 32"	3 x 27 mp. gal.	3 x 32 USG	21" x 57" x 32" (Overall)	EM171-181832S3
18" x 24" x 32"	3 x 35 mp. gal.	3 x 38 USG	21" x 75" x 32" (Overall)	EM171-182432S3

DUAL INSULATED SQUARE TANKS ON CASTERS WITH VALVE AND SKIRT				CODE
18" x 24" x 32"	2 x 35 mp. gal.	2 x 38 USG	21" x 51" x 32" (Overall)	EM190-182432S3

Filter press

7" SQUARE FILTER PRESS	CODE
7" filter press, 3 hollows, 2 plates, with pumping unit diaphragm electric 1/2"	SR012-030207XX
7" filter press, 3 hollows, 2 plates, w/o pumping unit and w/o swivel support	SR010-030207XX
7" filter press, 8 hollows, 7 plates with pumping unit diaphragm electric 1/2"	SR012-080707XX
7" filter press, 8 hollows, 7 plates, w/o pumping unit and w/o swivel support	SR010-080707XX
7" filter press, 10 hollows, 9 plates with pumping unit diaphragm electric 1/2"	SR012-100907XX
7" filter press, 10 hollows, 9 plates, w/o pumping unit and w/o swivel support	SR010-100907XX
Extra hollow and plates 7"	SR011-000007XX

10" SQUARE FILTER PRESS	CODE
10" filter press, 3 hollows, 2 plates with pumping unit diaphragm electric 1/2"	SR012-030210XX
10" filter press, 3 hollows, 2 plates, w/o pumping unit and w/o swivel support	SR010-030210XX
10" filter press, 7 hollows, 6 plates with pumping unit diaphragm electric 1/2"	SR012-070610XX
10" filter press, 7 hollows, 6 plates, w/o pumping unit and w/o swivel support	SR010-070610XX
10" filter press, 10 hollows, 9 plates with pumping unit diaphragm electric 1/2"	SR012-100910XX
10" filter press, 10 hollows, 9 plates, w/o pumping unit and w/o swivel support	SR010-100910XX
Extra hollow and plates 10"	SR011-000010XX

FRAME	CODE
7" and 10" stainless steel standard swivel frame with robust wheels (not included with the purchase of a press)	SR405-000002XX

You can add plates according to your needs on our square filter press.

UPON PURCHASE OF A COMPLETE FILTER PRESS W/O PUMPING UNIT:

- Hoses, connections and pan
- 3/4" ball valve for the pan



15" SQUARE FILTER PRESS	CODE
15" filter press, 6 hollows, 5 plates w/o pumping unit	SR010-060515XX
15" filter press, 8 hollows, 7 plates w/o pumping unit	SR010-080715XX
15" filter press, 7 hollows, 6 plates, w/o pumping unit and w/o swivel support	SR010-070615XX
15" filter press, 11 hollows, 10 plates w/o pumping unit	SR010-111015XX
15" filter press, 13 hollows, 12 plates w/o pumping unit	SR010-131215XX
15" filter press, 26 hollows, 25 plates with double inlets and outlets w/o pumping unit	SR010-262515XX
15" additional, hollows and plates	SR011-000015XX

PUMPING UNIT OPTION FOR 15" SQUARE FILTER PRESS	CODE
1/2" Yamada diaphragm pumping unit	SR003-150008NX
1" Yamada diaphragm pumping unit	SR003-150016NX
pumping unit 3 pistons with Y51XN pump, 1/2 HP	SR003-080751XNA

SHELF & VALVE OPTION FOR 15" FILTER PRESS	CODE
shelf option for Yamada & Y51 pumping unit (only on purchase of a 15" square filter press with pumping unit)	SR405-150237TX
3 way valve option with ss JIC 3/4" adaptor	SR405-151212KJ
3 way valve option with 1/2" quick coupling	SR405-151208KR



DIAPHRAGM PUMPING UNIT	CODE
Yamada diaphragm syrup pump 1/2"	SR003-000008NX
Yamada diaphragm syrup pump 1"	SR003-000016NX

Each pumping unit includes pressure and bypass hoses.



ELECTRIC DIAPHRAGM PUMPING UNIT	CODE
A - Pumping unit diaphragm electric 1/2"	SR003-000008EX
B - Pumping unit diaphragm electric 1/2" including connection hose	SR003-000008KT



POMPCO S-275 ALL STAINLESS HEAD	CODE
Syrup filter pumping unit (includes pressure and bypass hoses)	SR003-000275XX

REPLACEMENT DIAPHRAGM PUMP	CODE
Yamada diaph. syrup pump 1/2" 4 gal/min @ 50 PSI, 7 SCFM	PM006-000008A1
Yamada diaph. syrup pump 1" 25 gal/min @ 50 PSI, 25 SCFM	PM006-000016A1
1/4" regulator filter for diaphragm syrup pump	PM204-534221XX

KIT OF REPAIR	CODE
Liquid repair kit for Yamada diaphragm pump 1/2" model NPD-15BAH	PM206-080015KTMH
Liquid repair kit for Yamada diaphragm pump 1" model NPD-25BAH	PM206-160025KTMH
Liquid repair kit for Yamada diaphragm pump 1/2" model G15AH11	PM266-080015KTMH
Liquid repair kit for Yamada diaphragm pump 1" model G25AH11	PM266-160025KTAH

3 PISTONS PUMPING UNIT	CODE
1/2 HP Baldor motor with Y51 pump (with aluminium suction and piston chamber)	SR003-080751XNA

RESTRICTION PLATE FOR SQUARE FILTER PRESS	CODE
SS 10" plate	SR405-101832S4
SS 15" Plate	SR405-151632S4



Filter cloth



Diatomaceous earth



Filter paper



Restriction plate



Double hollow

ACCESSORIES	CODE
12" Washable filter cloth 1 micron (pkg/2)	DV400-011202XX
12" Washable filter cloth 5 microns (pkg/2)	DV400-001202XX
24" Washable filter cloth 5 microns (pkg/1)	DV400-002401XX
O'ring #253, 5-3/8"	DV201-000253XX
Dicalite Diatomaceous earth (filter aid) 10 lb	DV403-010010XX
Dicalite Diatomaceous earth (filter aid) 50 lb	DV403-010050XX
White filter papers 7" (box/400)	DV404-000007XX
White filter papers 10" (box/400)	DV404-000010XX
White filter papers 15" (box/250)	DV404-000015XX
6' translucent tubing assembled with SS hook and fitting 1/2"	SR200-000027XX
6' translucent tubing assembled without SS hook and fitting 1/2"	SR200-000027AX

DOUBLE HOLLOW PLATES	CODE
Double hollow plate 7" (o'rings not included)	SR405-070008RX
Double hollow plate 10" (o'rings not included)	SR405-100007RX

Available on 7" and 10" presses. By removing plates or lengthening the press, the addition of double frames allows for greater filtration capacity.

Sirofilter

SIROFILTER	CODE
12" Sirofilter complete w/o pumping unit	SR002-000012XX
12" Sirofilter complete with pumping unit diaphragm electric 1/2"	SR001-080012EX
24" Sirofilter complete w/o pumping unit	SR002-000024XX
24" Sirofilter complete with pumping unit diaphragm electric 1/2"	SR001-080024EX

UPON PURCHASE OF A COMPLETE SIROFILTER W/O PUMPING UNIT:

- Hoses, connections and pan;
- 3 washable filter cloths.



Pneumatic bottler system



Bottling valve kit



Bottling valve only

LAPIERRE PNEUMATIC BOTTLER SYSTEM	CODE
Lapierre pneumatic bottler system with manual control (bottling valve and tablet not included)	EM100-160102KT
Lapierre pneumatic bottler system with digital control (bottling valve and tablet not included)	EM100-160102CN
Option bottling valve 10 mm	EM306-062410KT
Option bottling valve 15 mm	EM306-062415KT
Lapierre pneumatic single bottler system with manual control and bottle guide (bottling valve not included)	EM306-020506CMS

OPTIONS	CODE
Option SS shelf (18")	EM306-161804KT
Bottling valve 10 mm	EM245-062410XX
O'ring and U-cup kit for bottling valve 10 mm	DV201-100245XX
Bottling valve 15 mm	EM245-062415XX
O'ring and U-cup kit for bottling valve 15 mm	DV201-150245XX

Example: To order a pneumatic bottler system with 4 bottling valves, you should use the code of the bottler system and 4 times the code of the option bottling valve.

Syrup water jacketed tanks

SYRUP WATER JACKETED TANKS	CODE
10 gal (12 USG) 20" x 16" 1 x 3000 W 2 syrup outlets	EM140-000010ST
Stand with adjustable shelf	EM340-201600ST
24 gal (29 USG) 32" x 20" 2 x 3000 W 4 Syrup outlets	EM140-000024ST
Stand with adjustable shelf	EM340-322000ST
34 gal (41 USG) 34" x 24" 2 x 3000 W 4 Syrup outlets	EM140-000034ST
Stand with adjustable shelf	EM340-342400ST
50 gal (60 USG) 38" x 28" 2 x 3000 W 4 Syrup outlets	EM140-000050ST
Stand with adjustable shelf	EM340-382800ST



10 gal (12 USG)



50 gal (60 USG)



HEATING ELEMENT (240 VOLTS)	CODE
3000 W element with temp. control	EM340-013000XX

GAS BURNER AND BOTTLING PAN

Complete kit: stand, burner, 16" x 16" stainless pan, outlet, filter rack, 3/4" draw off valve thermometer fitting 1/2", top lid and adjustable shelf.

GAS BURNER AND BOTTLING PAN	CODE
Complete kit	PE090-161600ST
Stainless bottling pan stand with adjustable shelf	FF016-161600ST
Gas burner with hose and regulator	ECRG016W
Mini steam pan (optional)	PP025-171701ST

SYRUP PANS (COVER AND OUTLET NOT INCLUDED)	CODE
16" x 16" x 14" (10" = 9.2 gal/11 USG)	PP009-161605ST
16" x 16" (3/4" outlet, nipple, ball valve, elbow, 1/2" dial fitting and plug included)	PP009-161607ST

8" or 10" = pan water level

SYRUP PAN OPTIONS	CODE
Pan cover 16" x 16"	PP027-161600ST
Syrup outlet 3/4" with valve and elbow (installed)	CS001-060006ST
Filter rack for 16" x 16" pan	PP027-161602S2



Cover not included



Cover not included



A



B



C



D

NEW



E



F



H

MAPLE CREAM MAKER

Available in 2 sizes, a professional 2 HP model with a 9000 series pump and a semi-professional 1/2 HP model using a 4000 series pump. Both features a stainless square funnel with cover.

MAPLE JELLY POWDER	CODE
Genugel 200 g	EM399-000200GR

CAN SEALER	CODE
A - IVESWAY auto-manual can sealer	ECMAY700
B - MASTER auto-manual can sealer	ECMAM200
C - Automatic Lapierre can sealer (120 volts)	EM100-000001XX
D - Automatic can sealer	EM100-000009XX

E - MAPLE CREAM MAKER 1/2 HP	CODE
The 1/2 HP model operates on regular 120 volts and will make the same quality of maple cream than the big model but the whole process will take between 12 and 15 minutes. Perfect for the producer making just a few hundred containers per season.	EM100-000004SP

F - MAPLE CREAM MAKER 2 HP	CODE
The 2 HP model operates on 240 volts single phase which allows the sugar maker to turn a perfect maple cream batch in 5 minutes. It is recommended for the producer that makes hundreds of containers per season.	EM100-000003SP

G - MAPLE CANDY MACHINE	CODE
A motor driven auger mixes the maple sugar with perfect consistency and feeds the candy mold (120 volts).	PP024-000001ST



SINCE 1980, SUGARHILL® HAS BEEN THE PLASTIC CONTAINER OF CHOICE FOR PURE MAPLE SYRUP CONTAINERS

- Full range of metric and standard sizes;
- Generic labels for Provinces and States;
- Tamper-evident caps with oxygen barrier foil liner;
- Distinctive trademarked traditional shape;
- Made from food-safe FDA approved recyclable resins;
- Colorful private label screen-printing available;
- Proprietary available XL Coating to maintain grade stability.

We have jugs in stock for Vermont, New York and All States.

Other states available upon request.

MAPLE CREAM CONTAINERS (USA)		CODE
250 ml	150/BOX	EXCUL250U
500 ml	125/BOX	EXCUL500U

USA		CODE
1 USG	24/BOX	EXCR4000
1/2 USG	32/BOX	EXCR2000
Quart	90/BOX	EXCR1000
Pint	100/BOX	EXCR0510
1/2 pint	100/BOX	EXCR0260
3.4 oz	100/BOX	EXCR0100

CANADA		CODE
4 L	24/BOX	EM022-004024CA
2 L	32/BOX	EM022-002032CA
1 L	96/BOX	EM022-001096CA
500 ml	100/BOX	EM022-500100CA
250 ml	100/BOX	EM022-250100CA
100 ml	100/BOX	EM022-100100CA



ALL STATE



STATES / maple cream



A



B



C



D



E



F



G



Black plastic closure



Gold tamper-evident plastic closure



Gold plastic closure

BOTTLES	CLOSURES NOT INCLUDED	CODE
A - Barrel, 200 ml	28 mm	EM045-080200XX
B - Silhouette 50 ml	18 mm	EM045-092450XX
B - Silhouette 100 ml	24 mm	EM045-090100XX
C - Erable 250 ml	28 mm	EM045-020250XX
D - Horizon 250 ml	28 mm	EM045-040250XX
E - Maple 375 ml	28-400 mm	EM045-030375XX
F - Tarquina erable 100 ml	28-400 mm	EM045-010100XX
F - Tarquina erable 250 ml	28-400 mm	EM045-010250XX

Bottles sold by the case only.
Volume discount available.
Closures sold by the bag only.

TAMPER-EVIDENT PLASTIC CLOSURE	CODE
18 mm Gold	EM046-000018GDS
24 mm Gold	EM046-000024GDS
28 mm Gold	EM046-000028GDS
28 mm Black	EM049-000028NRS

G - NUCAN BOTTLE (DOZEN)	CODE
Barrel style 125 ml	EM012-125035XX
Barrel style, 250 ml	EM012-250024XX
Barrel style 500 ml amber	EM090-010500XX
Barrel style 500 ml light	EM090-020500XX

NUCAN CLOSURE	CODE
Black NuCan closure	EM091-000000NR
Gold NuCan closure	EM091-000000GD

SUBSTITUTION CLOSURE	CODE
Universal black	EM021-000315NRS
White 'Mignon'	EM021-040001BXS

PLASTIC CLOSURE	CODE
28-400 mm Gold	EM047-028400GDS
33-400 mm Gold	EM087-033400GDS

Many available styles. Pricing is the same as the barrel.



A



B



C



D



E



F

BOTTLES	CLOSURES NOT INCLUDED	CODE
A - Basquaise, 40 ml	"Mignon"	EM030-040024XX
B - Maple leaf, 50 ml	18 mm	EM035-050048XX
B - Maple leaf, 100 ml	24 mm	EM035-100012XX
B - Maple leaf, 250 ml	24 mm	EM035-250012XX

BOTTLES	CLOSURES NOT INCLUDED	CODE
C - Snow flake, 250 ml	28 mm	EM040-010250XX
D - Kent, 250 ml	28 mm	EM048-010250XX
D - Kent, 375 ml	28 mm	EM048-010375XX
E - New Spirit, 1 L	Noir universel	EM043-100006XX
F - Medaillon, 50 ml	18 mm	EM042-050048XX
F - Medaillon, 250 ml	24 mm	EM042-250012XX

Bottle pictures are for reference only.
See closures on page 121.

Bottles sold by the case only.
 Volume discount available.

Many grade label
 models are available.
 Ask your Lapierre
 representative for details.



DISCOUNT WITH THE PURCHASE OF 50 STAINLESS STEEL DRUMS OR MORE



Drum (1 hem)



Drum (2 hems)



Drum truck

STAINLESS STEEL INOVAWELD DRUMS			CODE
22 imp. gal. (26 USG)	301-2B with 2 hems	29,75" high x 17,50" dia. ins.	BR001-002922S9
34 imp. gal. (40 USG)	301-2B with 2 hems	29,75" high x 20,75" dia. ins.	BR001-002934S9
34 imp. gal. (40 USG)	301-2B with 1 hem	29,75" high x 20,75" dia. ins.	BR001-002934S9BX
34 imp. gal. (40 USG)	304-2B with 2 hems	29,75" high x 20,75" dia. ins.	BR001-002934S4
45 imp. gal. (54 USG)	301-2B with 2 hems	35,00" high x 22,60" dia. ins.	BR001-003545S9
3/4" standard cap			BR408-010012J1
2" standard cap			BR408-010032J1
2" gasket			BR431-000032XX
Drum truck			BR005-000000XX
Drum tagging (maximum 14 characters)			BR004-000014XX

Cap 2" and 3/4" included on the cover (can be on the periphery of the cover instead of the center).



A

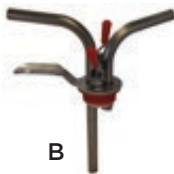

B



C



D

ACCESSORIES	CODE
A - Stainless steel pail 4 liters	DV093-000004S3
A - Stainless steel pail 9 liters	DV093-000009S3
A - Stainless steel pail 16 liters	DV093-000016S3
B - Drum transfer tool (only) 3/4"	BR010-000012XX
B - Drum transfer tool 3/4" kit	BR010-000012KT
C - Blue plastic jug 5 gal	EXBPL005

4" high heater belt, 120 volts, 1200 watts, with easy adjustable thermostat control. The temperature can be adjusted between 50 °F and 425 °F (10 °C and 218 °C).

D - HEAVY DUTY METAL DRUM HEATER BELT	CODE
34 and 40 gal drum	BR301-003440XX
45 and 55 gal drum	BR301-004555XX



STAINLESS STEEL DRUM FILLER TANK	CODE
51 gal (62 USG) 2' x 3' x 20" outlet 1" MPT	EM157-020320S3
Aluminum base	EM357-263840A1
Stainless steel lid	EM357-010203S3

BRIX EQUALIZER TANK (INSULATED) 250 GAL	CODE
Complete including: one insulated SS tank 250 gal with complete Brix balancer mixer, one frame ss with wheels for Brix tank, one aluminium ladder, one in-line refractometer 0-80 Brix assy, one pumping unit diaphragm electric 1/2"	EM165-000250KT
(Kit) including: one insulated SS tank 250 gal with complete Brix balancer mixer, one in-line refractometer 0-80 Brix assy, one pumping unit diaphragm electric 1/2"	EM165-010250KT

OPTION BRIX EQUALIZER TANK	CODE
Option frame w/o wheel & ladder	EM265-020400KT
Option wheels (4) for frame	EM265-050000KT

BRIX READER	CODE
0-80 Brix assembly mounted on bracket & ready to be installed on equipment	DV176-000080KT

PLASTICA MAPLE SYRUP DRUM	CODE
6 gal (7 USG) plastic drum, 1 cap	BR001-000006J1
16 gal (19 USG) plastic drum, 1 cap	BR001-000016J1
35 gal (42 USG) plastic drum, Evolution model, 1 cap*	BR001-000035J2
35 gal (42 USG) plastic drum, Evolution model, 2 caps*	BR001-000235J2

*Sampling cap and extension tube included.



PLASTICA ACCESSORIES	CODE
Adaptor for drum	BR400-000000J1
2" standard cap large thread	BR405-000032J1
2" standard cap, large thread for 3/4" valve	BR407-120032J1
Key for drum	BR420-000000XX
Sample extraction tool	BR428-000000XX



A



B

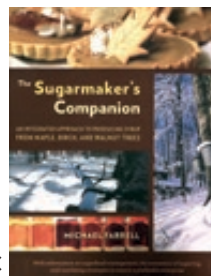

C



D



E

BOOKS	CODE
A - L'état de santé des érablières (french only) Carine Annecon, Rock Ouimet et Jean-David Moore	ECGUIDESE
B - Registre de production du sirop d'érable (french only) Center Acer	DV900-000001FX
C - The Sugarmaker's companion Michael Farrell	PA990-000003XX
D - Érable: 100 recettes sucrées et salées (french only)	PA991-000001XX
E - Sanitisation of collection systems using isopropyl alcohol - Center Acer	DV900-000002AX
OMSPA Sweet Ontario Recipe Books - Our favorite maple recipes	PA990-000004XX

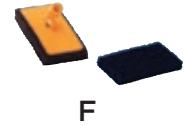
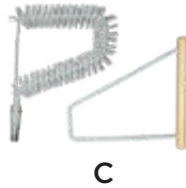

CLEANING ACCESSORIES	CODE
20" hand brush for evaporator	DV072-000020XX
A - 5/16" spout brush	DV073-000005XX
A - 7/16" spout brush	DV073-000007XX
B - Flue brush	DV074-000732XX
C - White nylon flue brush 7" x 2"	DV075-000732XX
C - White nylon flue brush 7" x 1/2"	DV075-000708XX
Brush for flue pan, interior 9" x 1/2" white nylon	DV075-000908XX
Brush for flue pan, exterior 9" x 2" white nylon	DV075-000932XX



PAN AND TUBING CLEANERS	CODE
Super Clean 85% 1 gal	DV430-000004XX
Super Clean 85% 5 gal	DV430-000020XX
Pan-O-Net 1 gal	DV431-000004XX
Top Net 1 gal	DV432-000004XX
Top Net 5 gal	DV432-000020XX
Myster pan 85% 4 L	DV630-850004XX
Myster pan 85% 20 L	DV630-850020XX
Acid pan 1 gal	FC3051GAL
Acid pan 5 gal	FC3055GAL



STAINLESS STEEL CLEANER	CODE
400 ml	DV494-000400XX



POWDER PAN CLEANER	CODE
Stainless steel pan cleaner 10 lb (LWS)	DV493-000010XX
Sulphamic acid powder pan cleaner 50 lb	DV419-000025XX

CLEANING ACCESSORIES	CODE
D - Brush - tube pan 7" (Turbo 2) or flue pan	DV076-000001XX
D - Brush - tube pan 9" (Turbo 3)	DV076-000002XX
Brush for Turbo pipe 9" model	AO103-000002ST
Extension for brush on turbo pipe 9"	AO103-000001ST
Complete assembly of the brush for 9" Turbo pipe	AO003-000001ST
E - 1" mainline brush	DV080-000016XX
E - 1 1/4" mainline brush	DV080-000020XX
E - 1 1/2" mainline brush	DV080-000024XX
E - 2" mainline brush	DV080-000032XX
F - Base only for 9" blue removable cotton cloth	DV085-000009XX
F - 9" blue removable scrubbing pad	DV088-000009XX

FOOD GRADE ISOPROPYL ALCOHOL 70% (CANADA ONLY)
4 L (1 gal)
20 L (5 gal)
205 L (45 gal)

Sani-Marc's 70% isopropyl alcohol (IPA) is ready to use, it is approved by the CFIA (Canadian Food Inspection Agency) to be used for the sanitization of sap tubing systems. Follow the recommended method published by Center Acer.

(Available for Canadian customers only).

For more information, please refer to your Lapierre representative.

CHLORINE	CODE
20 L	DV421-000020XX



USA'S DEALERS

INDIANA

Harris Sugar Bush

Arthur and Rebecca Harris
999 East County Road 325 North
Greencastle, IN 46135
Phone: 765 653-5108
Cell.: 765 301-0016
aharris@joink.com
www.harrissugarbush.com

MAINE

Suga Country Products

Joe and Adele Suga
871 Cross Hill Road
Vassalboro, ME 04989
Phone: 207 923-3355
Cell.: 207 592-7351
sugacountryproducts@gmail.com
www.sugacountryproducts.com

Bacon Farm Maple Products

Shelley & Kevin Bacon
1427 Pond Rd.
Sidney, Me 04330
Sugarhouse: 207 547-5053
Cell.: 207 314-8289
Shelly@baconfarmmaple.com
www.baconfarmmaple.com

MASSACHUSETTS

Hickory Hill Farm

Paul Sena
159 Buffington Hill Road
P.O. Box 272
Worthington, MA 01098
Phone: 413 238-5514
Cell.: 413 896-2720
hickoryhillmaple@gmail.com
www.worthingtonballooning.com

MICHIGAN

Great Lakes Maple Supply

Dale Forester
5785 Gamble Road
Atlanta, MI 49709
Phone: 269 625-6738
Phone: 269 503-0259
info@greatlakesmaplesupply.com
www.greatlakesmaplesupply.com

Mazurek Maple Supplies

Loren, Lisa and Lynn Mazurek
5056 N. Clark Rd.
Woodland, MI 48897
Phone: 616 755-3626 (store)
mazurekmaple@gmail.com

NEW HAMPSHIRE

Bascom's Maple Farms Inc.

Bruce Bascom
56 Sugar House Road
Alstead, NH 03602
Phone: 603 835-6361
Fax: 603 835-2455
sales@bascommapple.com
www.bascommapple.com

Dustin's Sugarhouse

Alan and Kathleen Dustin
49 Murphy Hill Road
Alstead, NH 03602
Phone: 603 835-6070
Cell.: 603 313-3878
dustinssugarhouse@gmail.com

Fuller's Sugarhouse

Dave Fuller
267 Main Street
Lancaster, NH 03584
Phone: 603 788-2719
Toll free: 877 788 2719
Fax: 603 788-4221
info@fullerssugarhouse.com
www.fullerssugarhouse.com

NEW YORK

Effley Falls Sugar Shanty

Kenneth Zehr
9601 Frank Kirch Road
Croghan, NY 13327
Phone: 315 771-2368
bkzehr@hughes.net

Shaw's Maple

Curt and Carol Shaw
7945 Maxwell Road
Clinton, NY 13323
Phone: 315 853-7798
info@shawsmappleproducts.com

Big Tree Maple

Lloyd Munsee
2040 Holly Lane
Lakewood, NY 14750
Phone: 716 763-5917
Cell.: 716 487-7633
Fax: 716 763 3257
lmunsee@bigtreemaple.com
www.bigtreemaple.com

Sage Family Maple LLC.

4449 Sage Rd.
Warsaw, NY 14569
Phone: 716 560-0742
hamilton@sagefamilymaple.com

Rand Hill Maple

David Smart
2395 Rand Hill Road
Altona, NY 12910
Phone: 518 493-7441
Cell.: 518 420-3733
randhillsmart@gmail.com

Widrick Maple

Phillip and Alayne Widrick
21243 Staplin Road
Black River, NY 13612
Phone: 315 775-4964
widrickmaple@yahoo.com

Ridge Creek Farm Maple Supply

Ken Lango
3923 Piety Ridge Road
Marathon, NY 13803
Cell.: 845 243-1197
klango125@gmail.com

OHIO

Devin Randall
102 Airport Access Road
Swanton, VT 05488
Phone: 802 868-2328
Cell.: 518 260-6746
devin.randall@elapierre.com

Gingerich Family Sugarbush

Erwin Gingerich III
14875 Georgia Road
Middlefield, OH 44062
Day: 440 478-6201
Eve: 440 834-8816

Stumpwater Farm LLC.

Al & Jared Baxter
29499, Clark Road
Sullivan, OH 44880
Phone: 419 736-3576
Cell.: 419 606-2213
stumpwater@outlook.com



PENNSYLVANIA

Brookfield Maple Products

Bud Bowers
111 Plank Road
Westfield, PA 16950
Phone: 814 367-5284
Cell.: 570 439-0969
bbowerslsg@gmail.com

Frost Ridge Maple Farm

Pat and Michele Mihailov
14611 Dickson Street
Guys Mills, PA 16327
Phone: 814 337-2483
Cell.: 814 720-9656
frostridge@zoominternet.net
www.frostridgemaplefarm.com

Loch's Maple

Randy and Jamie Loch
143 Cokely Road
Springville, PA 18844
Phone: 570 965-2679
maple4u@epix.net
www.lochsmapple.com

VERMONT

Goodrich's Maple Farm

2427 US Route 2
Cabot, VT 05647
Phone: 800 639-1854
Fax: 802 426-3388
goodrichsmapple@yahoo.com

Emerson Sugarhouse

Mike Emerson
2040 Snake Road
Newbury, VT 05051
Phone: 802 429-2100
Cell.: 802 356-4914
emersonsugarhouse@fairpoint.net

Maple Brothers

Kevin Heiden
138 Quarry Road
Perkinsville, VT 05151
Phone: 802 263-9487
Phone: 802 384-8312
kheiden@tds.net

Corse Maple Farm

Roy Corse
773 Corse Road
Whitingham, VT 05361
Phone: 802 368-2420
corsemaplefarm@myfairpoint.net
www.corsemaplefarm.com

Kevin Spaulding

102 Airport Access Road
Swanton, VT 05488
Bureau: 802 868-2328
Cell.: 802 370-0925
kevin.spaulding@elapierre.com

Whites Maple Equipment

Charlie & Ryan White
695 Danby Pawlet Road
Danby, VT 05739
Phone: 802 293-5409
Phone: 802 293-5609
whitesmapleequipment@gmail.com

Mount Pleasant Sugarworks

Donna & Andy Hutchison
2668, US Route 7
Leicester, VT 05733
Phone: 802 247-3117
Toll Free: 800 439-3117
mtpleasantmaple@gmail.com

**Brassard Sugarworks
and Maple Supply LLC**

Dan Brassard
849 VT RT 14 N
East Randolph, VT 05041
Phone: 802 839-9939
brassardsugarworks@gmail.com

Ronnie Sheltra

102 Airport Access Road
Swanton, VT 05488
Phone: 802 868-2328
Cell.: 802 370-4892
ronnie.sheltra@elapierre.com

Maple Hollow

Joe Polak
W1887 Robinson Drive
Merrill, WI 54452
Phone: 715 536-7251
info.maplehollow@frontier.com
www.maplehollowsyrup.com

Sipl's Sugarbush

Andy Sippl
N12020 Tamrack Road
Birnamwood, WI 54414
Phone: 715 449-3426
Cell.: 715 216-4627
sipplssugarbush@hotmail.com
www.siplssugarbush.com

Midwest Maple Supply

Whitney Rinehart
N2611 Rinehart Drive
Athens, WI 54411
Phone: 715 560-2222
midwestmaple@gmail.com



QUÉBEC CHAUDIÈRE / APPALACHES

Camil Gosselin

138, route 204
Ste-Justine, QC G0R 1Y0
Phone: 418 383-3167
Cell.: 418 625-0046
ca.gosselin@sogetel.net

Centre de Rénovation du Cap

A/S André Nichol
64, rue du Manoir Ouest
Cap-St-Ignace, QC G0R 1H0
Phone: 418 246-3456
Cell.: 418 241-3257
andrenichol12@gmail.com

François Gagnon

25, rue de l'Érablière
Ste-Claire, QC G0R 2V0
Cell.: 418 883-5601
francois.gagnon@elapierre.com

Marcel Morissette (Point de vente)

171, boulevard Bégin,
Ste-Claire, QC G0R 2V0
Phone: 418 883-3388
nmorissette@mmorissette.net

Les Entreprises KéPasc

Keven Poulin/Kathy Pruneau
Pascal Pruneau/Jessy Roy
440, 6^e avenue
Saint-Georges, QC G5Z 0R6
Phone: 418 228-6118
Cell.: 418 313-3073 (Kathy)
Cell.: 418 225-3129 (Keven)
Cell.: 418 225-7951 (Pascal)
kathy.pruneau@kepasc.com

R.D. Langlois

Réjean Langlois
1039, rue Principale
Tourville, QC G0R 4M0
Phone: 418 359-3064
Cell.: 418 356-6420
deschenes-d@hotmail.com

Mathieu Lachance

99, rue de l'Escale
St-Ludger, QC G0M 1W0
Cell.: 418 226-5047
mathieu.lachance@elapierre.com

Quincaillerie Champagne (Point de vente)

Marika Demers
417, 9^e rang
St-Honoré, QC G0M 1V0
Phone: 418 485-6459
marika@quincailleriechampagne.ca

Sébastien Berthiaume

105, rue Industrielle
St-Jacques-de-Leeds, QC G0N 1J0
Phone: 418 424-3030
Cell.: 418 882-7605
sebastien.berthiaume@elapierre.com

ST-ULBADE ET ENVIRONS

Quincaillerie BMR Pierre Naud Inc.

Félix Lemay
464, rue St-Paul
St-Ubalde, QC G0A 4L0
Phone: 418 277-2225
Cell.: 418 336-2413
f.lemay@pierrenaud.com

RIVE-NORD

Installation Picaouette Inc.

Régis Caouette
8121, route Arthur-Sauvé
Mirabel, QC J7N 2R6
Phone: 450 258-3888
Fax: 450 258-1185
Cell.: 514 703-1688 (Régis)
Cell.: 514 208-0255 (Catherine)
picaouetteinc@hotmail.com

Georges Paradis

785, rue de Villieu
Terrebonne, QC J6X 1I7
Phone: 450 471-0299
Cell.: 514 242-7878
georges.paradis99@gmail.com

ESTRIE / CENTRE-DU-QUÉBEC

Équip. d'Érablière Verville Inc.

Pierre et Stéphane Verville
466, avenue Pie-X
St-Christophe-d'Arthabaska,
QC G6R 0M9
Phone: 819 357-4322
Cell.: 819 352-2998 (Pierre)
Cell.: 819 352-1595 (Stéphane)
info@eeverville.com

Équipements Érablière RC Inc.

Rémi Castonguay
2905 route Principale
St-Édouard-de-Lotbinière, QC G0S 1Y0
Phone: 581 446-2705
Cell.: 418 575-8269
remi_castonguay@hotmail.com

Centre de rénovation de l'anse Inc.

118, route 170
L'Anse-Saint-Jean, QC GOV 1J0
Phone: 418 272-2411
dave.gagne@homehardware.ca

Pierre Bouchard

201, rue Western
Waterloo, QC JOE 2N0
Phone: 450 539-3663
Cell.: 450 204-0731
pierre.bouchard@elapierre.com

Charles Lachance

99, rue de l'Escale
St-Ludger, QC G0M 1W0
Phone: 819 548-5454
Cell.: 418 225-6595
charles.lachance@elapierre.com

Prodane

142 rang St-Joseph
La-Visitation-de-Yamaska, QC JOG 1C0
Cell.: 450 899-2776 (Dave Daneau)
Cell.: 819 386-2515 (Audrey Alie)
pro.dane@elapierre.com

QUEST DU QUÉBEC

Francois Benny

212, rang St-Charles
Havelock, QC JOS 2C0
Cell.: 514 796-3358
f.benny@hotmail.com



**BAS-SAINT-LAURENT /
CÔTE SUD**

Forêtmax

Succursale Squatec

Denis Ouellet, Yoann Belisle
et Robert Lévesque
139A, rue St-Joseph
Squatec, QC G0L 4H0
Phone: 418 855-1049 (Magasin)
Cell.: 418 551-6443 (Yoann)
Cell.: 418 551-4761 (Robert)
amenagementforetmax@bellnet.ca
foretmaxyoann@bellnet.ca
levesque98@hotmail.com

Forêtmax

Succursale Pohénégamook

Julien Chouinard
1415, route 289 (Principale)
Pohénégamook, QC G0L 1J0
Phone: 418 859-3030
Cell.: 418 860-7882
julien.foretmax@gmail.com

Lapierre Saint-Cyprien

101, rue Ouellet
Saint-Cyprien de Rivière-du-Loup
QC G0L 2P0
Phone: 418 963-2361
Fax: 418 963-6559
mcyrien@elapierre.com

ABITIBI-TÉMISCAMINGUE

Danny Girard

156, rue Lafort
Témiscaming, QC J0Z 3R0
Phone: 819 627-7028
Cell.: 819 627-6041
dannygirard81@hotmail.com

NEW BRUNSWICK

Rocky Mountain Maple

David Briggs
2979, Main Street
Hillsborough, NB E4H 2X9
Phone: 506 382-3380
Cell.: 506 866-5946
dsbriggs@nbnet.nb.ca

Lapierre St-Quentin

Maxime Lord et Daniel Savard
165, route 260
St-Quentin, NB E8A 2L5
Phone: 506 235-2793
Cell.: 506 760-0088 (Maxime)
Cell.: 506 253-1536 (Daniel)
Fax: 506 235-2792
maxime.lord@elapierre.com

NOVA SCOTIA

Kevin McCormick Sales and Service

Kevin McCormick
789 Rodney Road
Springhill, NS B0M 1X0
Cell.: 902 694-0145 (Kevin)
Cell.: 902 694-5943 (Brad)
kevinmccormick@seasidehighspeed.com

ONTARIO

**Springdale Farm Maple
Equipment and Supplies**

Stephen Dodds
1790 Galbraith Road RR2
Clayton, ON K0A 1P0
Phone: 613 256-4045
Cell.: 613 250-0493
info@springdalemaple.ca
www.springdalemaple.ca

Weber Sugarbush Supplies Inc.

**Waterloo Wellington
and Southwestern Ontario**

Harvey Weber
2844 Lobsinger Line
Heidelberg, ON N0B 2M0
Phone: 519 699-4769

**Squirrel Creek Farm Ltd
Central Ontario**

Steven, Rachael & Christopher
275 Brackenridge Drive
RR2 Millbrook, ON L0A 1G0
Phone: 705 932-2868
Cell.: 705 872-7629 (Steven)
steven@squirrelcreek.ca
rachael@squirrelcreek.ca
maple@squirrelcreek.ca
www.squirrelcreek.ca

**Reist Farm Supplies Inc.
Waterloo Wellington
and Southwestern Ontario**

Edgar and Edwin
6681 Line 86 RR2
Elmira, ON N3B 2Z2
Phone: 519 669-1422

Garland Sugar Shack

Ivan and Jocelyne Garland
5930 Garlandside Road
Vars, ON K4B 1S9
Phone: 613 835-3362
Cell.: 613 327-3050
garlandsugarshack@gmail.com

**Maple Ridge Farm
Manitoulin and North Shore /
St. Joseph Island**

Brian Bainborough
228 Smith Bay Road
Gore Bay On POP 1H0
Cell.: 705 229-9345
Fax: 705 797-8427

PRODUCTION REGISTER

#	DATE	TEMP.	DRUM #	COLOR	BRIX	GRADE	NOTE

PRODUCTION REGISTER

#	DATE	TEMP.	DRUM #	COLOR	BRIX	GRADE	NOTE

NOTES



LES ÉQUIPEMENTS LAPIERRE INC.

(head office)
99, rue de l'Escale
Saint-Ludger, Beauce, QC
G0M 1W0
1 833 548-5454
Phone: 819 548-5454
Fax: 819 548-5460
info@elapierre.com

MANUFACTURING/SERVICE

DISTRIBUTION CENTER

LAPIERRE-WATERLOO-SMALL

201, rue Western
Waterloo, QC
J0E 2N0
Phone: 450 539-3663
Fax: 450 539-2660
info.lws@elapierre.com

MANUFACTURING/SERVICE

DISTRIBUTION CENTER

LAPIERRE USA SWANTON

102 Airport Access Road
Swanton, VT
05488
Phone: 802 868-2328
Fax: 802 868-9281
info.usa@elapierre.com

SERVICE

DISTRIBUTION CENTER

LAPIERRE SAINT-CYPRIEN

101, rue Ouellet
Saint-Cyprien de Rivière-du-Loup, QC
G0L 2P0
Phone: 418 963-2361
Fax: 418 963-6559
mcyrien@elapierre.com

DISTRIBUTION CENTER

LAPIERRE ST-QUENTIN

165, Route 260
St-Quentin, NB
E8A 2L5
Phone: 506 235-2793
Fax: 506 235-2792
maxime.lord@elapierre.com

DISTRIBUTION CENTER

LAPIERRE SAINT-JACQUES-DE-LEEDS

105, rue Industrielle
Saint-Jacques-de-Leeds
G0N 1J0
Phone: 418 424-3030
Fax: 418 424-3000
mstjacques@elapierre.com

DISTRIBUTION CENTER

Your sales representative



99, rue de l'Escale, Saint-Ludger, Beauce, QC G0M 1W0 CANADA
TF.: 833 548-5454 | Fax.: 819 548-5460 | info@elapierre.com | www.elapierre.com