





The Bittersweetness of the Seasons

2023 was mediocre for most producers. Indeed, after a season teeming with blond gold in 2022, production in 2023 was marked by a Canada-wide decrease of nearly 40% compared to the previous year. As a result, it left too many maple syrup producers wanting more. Add to this the faltering economy and the upheavals in the inflation and interest rates, and it is easy to understand why people in the industry found themselves in an environment covered in a disappointing greyness.

Of course, these challenges were there for everyone: for you as producers and for us as a manufacturer. Under the circumstances, we have taken on our role as a collaborator with our maple syrup producers. We have spoken with our partners to take advantage of benefits that would reduce impacts, while internally, the continuous monitoring of our manufacturing processes has also contributed to helping our customers.

It must obviously be emphasized that maple syrup producers of old and new strains know how to tell things apart. They recognize that an overview of maple syrup production must span several years. In addition, let's add that the medium-term economic prospects seem to indicate an improvement in the economic situation.

At LAPIERRE, we have been committed to maple syrup production for three generations. In the field, of course, like each of you, but also in the factory. We have therefore also tasted the bittersweetness of the seasons that have followed one another for several decades. Despite everything, it is always with great enthusiasm that we engage in the traditional ritual of each sugaring season.

LAPIERRE is a well-known name in the maple syrup industry. And the family nature of our business focused on meeting the needs of our customers is just as well-known. These needs are at the heart of the development of our products, which is why they are designed to be so efficient while being user-friendly. On the other hand, our promise of excellent service is also directly related to the closeness that we maintain with our customers. This explains why we favour the sustained improvement of our customer service department through investments in time as well as human and financial resources.

With respect to our products, we innovate in an eco-conscious and energy-efficient manner while developing reliable technologies without compromising the existing balance between our values and efficiency. Proactive, we are already innovating what will be on the market in the medium or even long term. We also invest in purchases of high-tech production equipment, including the one recently carried out at our extrusion plant. These innovations and investments are generated with the aim of offering you quality products at a fair price despite economic turmoil and uncertainties.

In conclusion, here is some excellent news for our industry: In January 2024, the PPAQ awarded 7 million additional taps to nearly 750 new maple syrup producers and 1900 growing maple syrup companies. Welcome and good luck to all these maple syrup producers.

Thank you for reading. We look forward to serving you very soon!

Chantal, Anick, Carl et Donald Lapierre



SAP GATHERING

- Tubing..... 6
- Fittings..... 8
- Accessories and miscellaneous 14

DATACER

- Sugarbush automation 18

EXTRACTORS

- Extractors and accessories 23
- Extractors and miscellaneous 31
- Water pumps 33

VACUUM PUMPS

- Pumps: Busch, Sihi 34
- Accessories 40

WATER STORAGE

- Stainless tanks..... 41
- Accessories 46

CONCENTRATION

- Reverse osmosis..... 47
- Accessories 57

EVAPORATION

- Evaporators..... 62
- Accessories and miscellaneous 73

TRANSFORMATION

- Filtration and conditioning..... 82
- Packaging 85
- Accessories and miscellaneous 90

DEALERS

- Dealers 92

2024 MARKS THE ARRIVAL OF THE

FLEXClip^{2.0}_{tm}

new generation

Patent Pending

If the **ingenious ease of installation** remains the key feature of this second generation, brand-new attributes come to reinforce its stability and sealing properties.

QUICK AND EASY INSTALLATION

Simple and intuitive installation procedure done in no time.

1. Clip
2. Drill
3. Turn
4. Screw

À VOIR
PAGE 13

MAX15

SEE
PAGE 7

TUBING WITH EXCEPTIONAL PROPERTIES

The brand new 5/16 semi-rigid is made from the best food grade resins to ensure excellent waterproofing, mnemonic elasticity (shape memory) and maximum transparency. The **MAX15** is the result of proven expertise as a user and extruder of maple syrup tubing.

The orientation, altitude and topography of your maple sugar bush will certainly have an influence on the performance of your collection system. The choice of a specific colour will also affect freezing and thawing cycles. Whether for a new installation, a new area or tubing replacement, the **MAX15** is the choice of maple syrup producers.

REFLEX SPOUT

FLEXIBLE NYLON, MEDIUM GREY

EXCELLENT BEHAVIOR IN FREEZE-THAW CYCLES

MAPLEFLEX offers a new hybrid sap spout, the best combination. Rethought and redesigned, it is the result of a successful collaboration between Lapierre and maple syrup experts. Made of flexible resin, the hybrid spout retains its original shape memory, which ensures optimal seal. The ideal compromise between thawing and freshness!

SEE
PAGE 8

ZMF
SAPRODUCTS



MAPLE FLEX®

GET THE BEST GATHERING SYSTEM AVAILABLE TODAY

Your gathering system is the backbone of your sugaring operation's profitability. We offer several categories of 5/16" and 3/16" tubing. Ask your representative today.

Lapierre Equipment is more than just a distributor. We manufacture our MapleFlex® 5/16" and 3/16" tubing and mainlines in our proprietary extrusion plant, **using only the best raw materials and the best U.V. protection** available. We produce and deliver with the highest quality standards in the business.

MAPLEFLEX® HIGH DENSITY MAINLINE

MapleFlex introduces you to a brand new high density (HD) mainline produced with the same features and production standards. Lighter and more affordable, the MapleFlex HD mainline provides the same vacuum resistance for the same diameter while being thinner.

HDPE food grade, more affordable, UV protection, aerial and underground installation, 10 year warranty.

MAPLEFLEX® HD MAINLINE (125 PSI)			CODE
MapleFlex HD 3/4"	Black	500 feet	TU007-120500H1
MapleFlex HD 3/4"	Black	2500 feet	TU007-122500H1
MapleFlex HD 1"	Black	500 feet	TU007-160500H1
MapleFlex HD 1"	Black	1500 feet	TU007-161500H1
MapleFlex HD 1 1/4"	Black	500 feet	TU007-200500H1
MapleFlex HD 1 1/4"	Black	1000 feet	TU007-201000H1
MapleFlex HD 1 1/2"	Black	500 feet	TU007-240500H1

SEMI-RIGID 3/16" MAPLEFLEX® TUBING (500')			CODE
MapleFlex® ULTRA15	15 years warranty	Light blue	TU386-000000XX
MapleFlex® ULTRA15	15 years warranty	Vision green	TU386-010000XX

Tools and accessories for 3/16" tubing are also available.



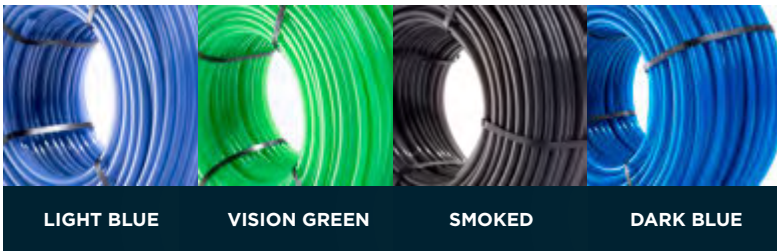

SEMI-RIGID 5/16" MAPLEFLEX® TUBING (500')	CODE
MapleFlex® ULTRA15 15 years warranty Light blue	TU086-000000XX
MapleFlex® ULTRA15 15 years warranty Vision green	TU086-010000XX
MapleFlex® ULTRA15 15 years warranty Smoked	TU086-040000XX
MapleFlex® MAX15 15 years warranty Light blue	TU084-000000XX
MapleFlex® MAX15 15 years warranty Vision green	TU084-010000XX
MapleFlex® MAX15 15 years warranty Smoked	TU084-040000XX
MapleFlex® MAX15 15 years warranty Dark blue	TU084-050000XX

BLUE MAPLEFLEX® MAINLINE (100 PSI)	CODE
3/4" 500', 2500'	TU002-12****H1
1" 500', 1000', 2000'	TU002-16****H1
1 1/4" 500', 1200'	TU002-20****H1
1 1/2" 500', 1200'	TU002-24****H1
2" 500'	TU002-32****H1

Our MAPLEFLEX® mainlines are made to work at the highest vacuum levels. Above 28 in/Hg. high vacuum allows for higher sap yields.

VISION GREEN MAPLEFLEX® MAINLINE (100 PSI)	CODE
3/4" 500', 2500'	TU014-12****H1
1" 500', 1000', 2000'	TU014-16****H1
1 1/4" 500', 1200'	TU014-20****H1
1 1/2" 500', 1200'	TU014-24****H1

Pre-cut or assembled drop lines
Standard lengths of 30", 36", 40" and 48" with tubing, spout and tee of your choice.

SMOKED MAPLEFLEX® MAINLINE (100 PSI)	CODE
1" 500', 1000', 2000'	TU013-16****H1
1 1/4" 500', 1200'	TU013-20****H1
1 1/2" 500', 1200'	TU013-24****H1

For any other lengths, a minimum quantity will be required.



BLACK MAPLEFLEX® MAINLINE (100 PSI)	CODE
1/2" 100', 400'	TU001-08****H1
3/4" 500', 2500'	TU001-12****H1
1" 500', 1000', 2000'	TU001-16****H1
1 1/4" 500', 1200'	TU001-20****H1
1 1/2" 500', 1200'	TU001-24****H1
2" 200', 500'	TU001-32****H1

To order mainline by specific length, replace ** by feet number.**

For 200', 400' and 500', add a 0 before the length
ex.: TU007-12****H1 = TU007-12**0500**H1

For 1000', 1200', 2000' and 2500' just replace the *
ex.: TU007-12****H1 = TU007-12**2500**H1

Spout

**IMPROVED
MODEL**



**NEW DESIGN
ENLARGED HEAD DESIGN
MAKES TAPPING EASIER**

REFLEX



ELBOW STYLE SPOUT (2 BARBS)

TYPE	TAP DIAMETER	TUBING DIAMETER	MATERIAL	COLOR	WALL	ZML	CODE
Reusable	1/4"	5/16"	Nylon	Black	Std	√	TU282-105504N4B
Reusable	1/4"	5/16"	Nylon	Dark blue	Std	√	TU282-105504N5B
Reusable	1/4"	5/16"	Soft nylon	Black	Std	√	TU282-105504Y4B
Seasonal	1/4"	5/16"	Soft nylon	Grey	Std	√	TU282-105504Y8B
Reusable	5/16"	5/16"	Nylon	White	Std	√	TU282-106505N1B
Reusable	5/16"	5/16"	Soft nylon	White	Std	√	TU282-106505Y1B
Reusable	5/16"	5/16"	Soft nylon	Black	Std	√	TU282-106505Y4B
Seasonal	5/16"	5/16"	Soft nylon	Grey	Std	√	TU282-106505Y8B

ELBOW STYLE SPOUT (1 BARB)

TYPE	TAP DIAMETER	TUBING DIAMETER	MATERIAL	COLOR	WALL	ZML	CODE
Seasonal	1/4"	3/16"	Polycarbonate	Clear	Thin	√	TU279-105604J9B
Reusable	1/4"	3/16"	Nylon	Black	Thin	√	TU279-105604N4B
Reusable	5/16"	3/16"	Nylon	Black	Thin	√	TU279-106105N4B
Reusable	5/16"	3/16"	Polycarbonate	Clear	Thin	√	TU279-106105J9B
Seasonal	5/16"	5/16"	Polycarbonate	Clear	Thin	√	TU279-106505J9B

SAP GATHERING | FITTINGS



Standard seasonal spout



Long seasonal spout

STRAIGHT SPOUT	TAP DIAMETER	TUBING DIAMETER	MATERIAL	COLOR	WALL	ZML	CODE
Standard seasonal spout with retaining ring	1/4"	5/16"	Polycarbonate	Clear	Std	✓	TU047-108034J9B
Long seasonal spout with retaining ring	1/4"	5/16"	Polycarbonate	Clear	Std	✓	TU047-108044J9B
Standard seasonal spout with retaining ring	5/16"	5/16"	Polycarbonate	Clear	Std	✓	TU047-109035J9B
Long seasonal spout with retaining ring	5/16"	5/16"	Polycarbonate	Clear	Std	✓	TU047-109045J9B



Short joint spout



LTS-USA spout

Designed by sugarmakers.
A minimal angle to strongly seal the tap hole.

ELBOW SPOUT SHORT JOINT	TAP DIAMETER	TUBING DIAMETER	MATERIAL	COLOR	WALL	ZML	CODE
Elbow, short joint	5/16"	5/16"	Polycarbonate	Clear	Thin	✓	TU281-106505J9B
LTS-USA 1,1570°	5/16"	5/16"	Polycarbonate	Clear	Std	✓	TU300-106705J9B
LTS-USA 1,1570°	5/16"	5/16"	Polycarbonate	Clear	Thin	✓	TU301-106705J9B



Retaining hooks

DESCRIPTION	TAP DIAMETER	TUBING DIAMETER	MATERIAL	COLOR	WALL	ZML	CODE
Y spout 130°	1/4"	5/16"	Polycarbonate	Clear	Thin	✓	TU285-103004J9B
Y spout 130°	1/4"	5/16"	Nylon	Blue	Thin	✓	TU285-103004N7B
Y spout 130°	5/16"	5/16"	Polycarbonate	Clear	Thin	✓	TU285-104005J9B
Y spout 130°	5/16"	5/16"	Nylon	Blue	Thin	✓	TU285-104005N7B



1 ST GENERATION SPOUT	TAP DIAMETER	TUBING DIAMETER	MATERIAL	COLOR	WALL	CODE
Seasonal elbow style spout	1/4"	5/16"	Polycarbonate	Clear	Std	TU048-000004J9B
Seasonal elbow style spout	5/16"	5/16"	Polycarbonate	Clear	Std	TU048-000005J9B

Please note that this Spout is not compatible with a Tee-plug.

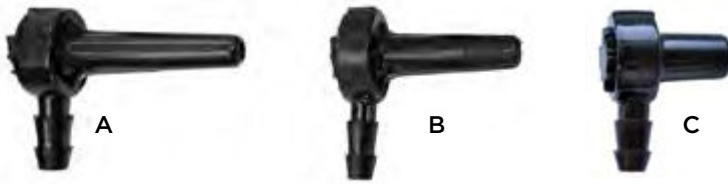

ORIGINAL SPOUT	TAP DIAMETER	TUBING DIAMETER	MATERIAL	COLOR	WALL	CODE
A - Elbow style spout	5/16"	5/16"	Nylon	Black	Std	TU051-000005J4B
B - Elbow style spout with rib	5/16"	5/16"	Nylon	Black	Std	TU050-000005J4B
C - Short spout	7/16"	5/16"	Nylon	Black	Std	TU055-000007J4B

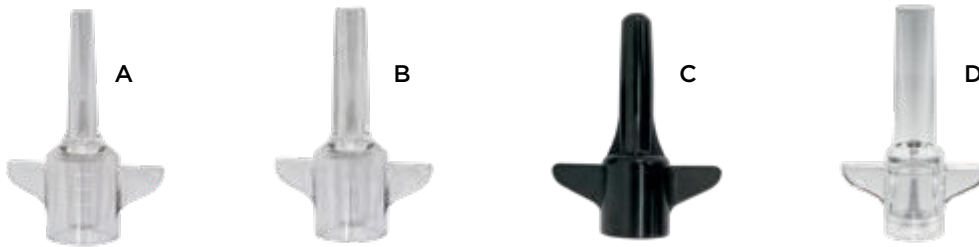

DESCRIPTION	TAP DIAMETER	ADAPTOR DIAMETER	MATERIAL	COLOR	WALL	CODE
A - Spout adaptor	1/4"	7/16"	Polycarbonate	Clear	Std	TU054-000416J9B
B - Spout adaptor	5/16"	7/16"	Polycarbonate	Clear	Std	TU054-000516J9B
B - Spout adaptor	5/16"	7/16"	Polycarbonate	Clear	Thin	TU254-000516J9B
C - Spout adaptor	5/16"	7/16"	Nylon	Black	Std	TU054-000516J4B
D - Spout adaptor	5/16"	5/16" and 19/64"	Polycarbonate	Clear	Thin	TU256-000516J9B

Stéricap



STERICAP AND HOOK	CODE
Blue	TU298-146005L7B

Stericap, is a reusable 5 ml. isopropyl alcohol tight sealed container.

No mould parting line at the spout tip or tubing connection to completely eliminate micro-leaks, will help reaching maximum vacuum levels and higher yields.

STARS	CODE
Star 3 way	TU020-000003J4
Star 4 way	TU020-000004J4
Star 6 way	TU020-000006J4

Fitting and adaptor

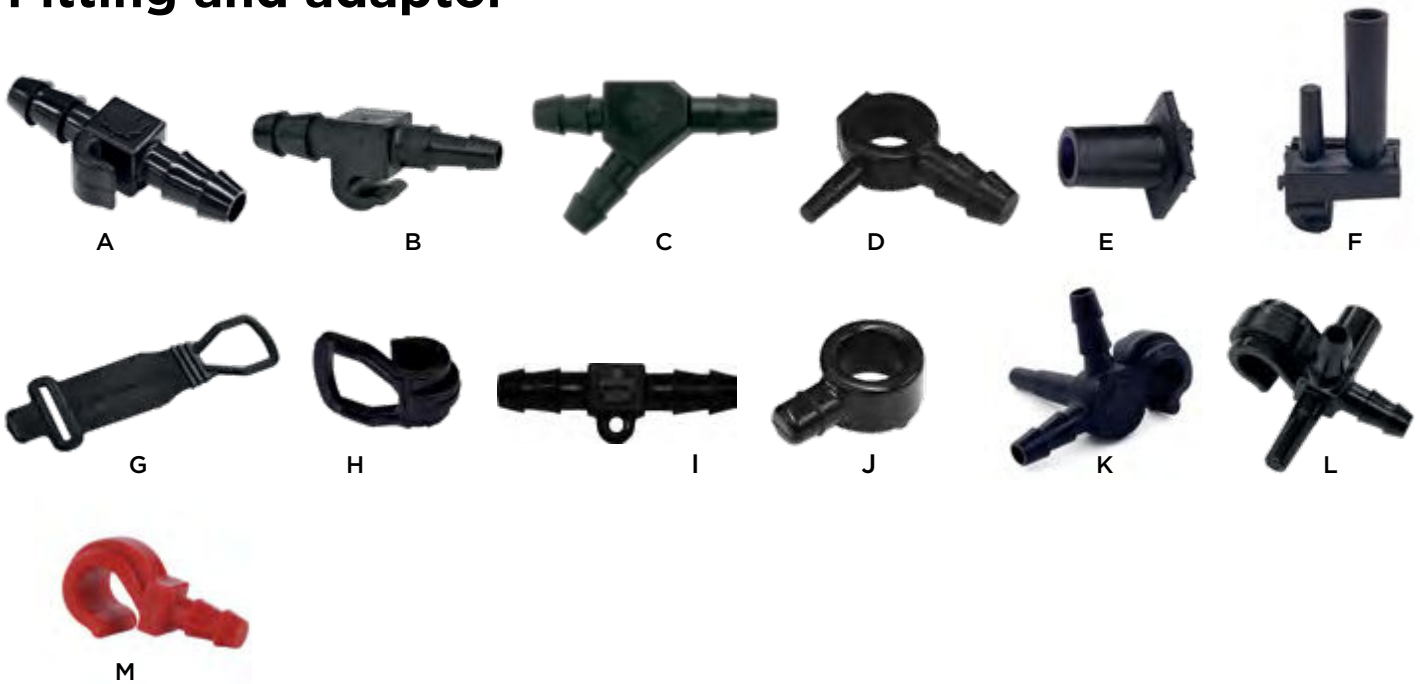

ORIGINAL FITTING (2 BARBS)	TUBING DIAMETER	MATERIAL	COLOR	ZML	CODE
A - Connector with hook	3/16"	Nylon	Black	√	TU134-020003J4
A - Connector with hook	5/16"	Nylon	Black	√	TU134-000002J4
B - Reducer hook connector	3/16" and 5/16"	Nylon	Black	√	TU334-020305N4
C - Y	5/16"	Nylon	Black	-	TU026-000000J4
D - End of line eyelet	5/16"	Nylon	Black	-	TU027-000000J4
E - Rubber plug	5/16"	Nylon	Blue	-	TU028-000000XX
F - Slide fitting	5/16"	Nylon	Black	-	TU030-000000J4
F - Slide fitting	3/16"	Nylon	Black	-	TU067-150103N4
G - End of line tie for slide fitting	5/16"	Nylon	Black	-	TU031-000000J4
H - End of line hook for slide fitting	5/16"	Nylon	Black	-	TU032-000000J4
I - Connector	5/16"	Nylon	Black	√	TU133-000002N4
J - Eyelet drop-line plug (seasonal spout)	5/16"	Nylon	Black	-	TU114-000000J4
K - End of line drop-line hook (3 ST)	3/16"	Nylon	Black	√	TU131-317002N4
L - End of line drop-line hook (3 ST)	5/16"	Nylon	Black	√	TU330-000002N4
L - End of line drop-line hook	5/16"	Nylon	Black	√	TU331-010205N4
M - End of line drop-line hook	5/16"	Nylon	Red	√	TU132-142500J03

Tee-plug



ORIGINAL TEE-PLUG (2 BARBS)	TUBING DIAMETER	MATERIAL	COLOR	ZML	CODE
A - Universal tee-plug 3 stages	5/16"	Nylon	Black	✓	TU240-020003J4
A - Universal tee-plug 3 stages	3/16"	Nylon	Black	✓	TU040-030200N4
B - Red tee-plug, 3 stages (left side plug)	5/16"	Nylon	Red	-	TU042-000003J03
C - Tee-plug with cap-plug and drop-line plug	5/16"	Nylon	Black	-	TU045-000504J4
D - Tee-plug with elongated cap	3/16"	Nylon	Black	✓	TU341-326002N4
D - Tee-plug with elongated cap	5/16"	Nylon	Black	✓	TU241-927002J4
E - Tee-plug with elongated cap and hook	3/16"	Nylon	Black	✓	TU342-327002N4
F - Tee-plug with cap-plug	5/16"	Nylon	Black	✓	TU241-000002J4

Fixed head and swivel head fittings black nylon



A - B



C

DESCRIPTION	DIAMETER	DRILL BIT SIZE	ZML	CODE
A - Saddle manifold with fixed head (fits on: 3/4", 1", 1 1/4", 1 1/2", 2")	3/16"	3/8"	-	TU122-060301J4
	3/16"	31/64"	-	TU122-310301J4
	5/16"	3/8"	✓	TU322-060201J4
	5/16"	31/64"	✓	TU322-310201J4
B - Saddle manifold with swivel head (fits on: 3/4", 1", 1 1/4", 1 1/2", 2")	5/16"	31/64" w/o clips	-	TU021-000001J4
C - Saddle manifold with tie-wrap (fits on: 3/4", 1", 1 1/4")	5/16"	31/64"	✓	TU323-310201J4
Tie-wrap (50 bag)				TU036-000000J4



SADDLE PRO	CODE
Saddle pro, black ZML with clips and seal (bag/25)	TU316-000001J4
Saddle pro, black ZML with clips and seal (box/500)	TU316-000001J4B

MAINLINE HOOK	CODE
Bag of 100	TU112-157500XX
Box of 1000	TU112-157500XXB

2024 MARKS THE ARRIVAL OF THE

FLEXClip™ 2.0

new generation

Patent Pending

If the **ingenious ease of installation** remains the key feature of this second generation, brand-new attributes come to reinforce its stability and sealing properties.

QUICK AND EASY INSTALLATION

Simple and intuitive installation procedure done in no time.

1. Clip
2. Drill
3. Turn
4. Screw

- Innovative integrated positioning and drilling template:
 - Extremely practical and unique template in the market,
 - Consistently positions the inlet at the ideal angle of 55 to 60 degrees,
 - Facilitates the installation of the lateral line and extends its integrity.
- Installs on any mainline with a diameter corresponding to the FLEXCLIP™ 2.0.

**SCAN
THE QR CODE**
to discover our
complete variety



ELAPIERRE.COM
Online Store



IMMOBILITY OF FLEXCLIP™ 2.0

- Protruding Chimney:
 - Prevents any movement of the FLEXCLIP™ 2.0 on the mainline,
 - The “click” sound simplifies the final placement of the FLEXCLIP™ 2.0.

MAINLINE INTEGRITY

- Since it rests on 87% of the mainline’s circumference, the FLEXCLIP™ 2.0 allows the tubing to maintain good circularity.

PROVEN SELF-ADHESIVE SEAL

- Made of food-grade silicone.
- Firmly pre-installed at the factory.
- New optimized dimensions for proven sealing.
- Receiving cavity:
 - Compact cavity that securely immobilizes the self-adhesive seal,
 - Bumpers that consistently ensure the ideal compression of the seal for optimal water-proofing.

DIMENSIONS

- 1 inch
- Other sizes available soon

STAINLESS STEEL SCREW

- Included

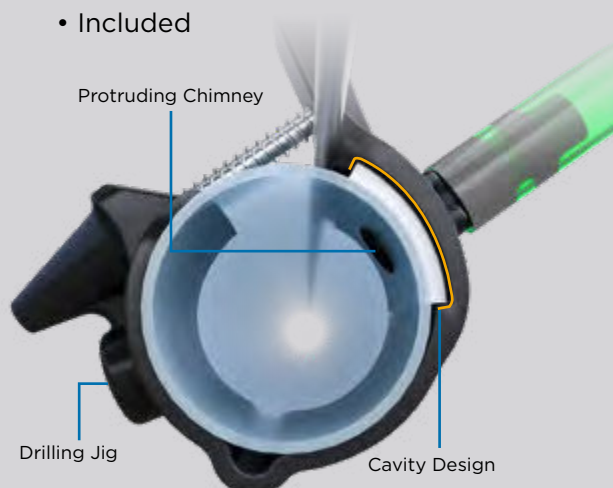

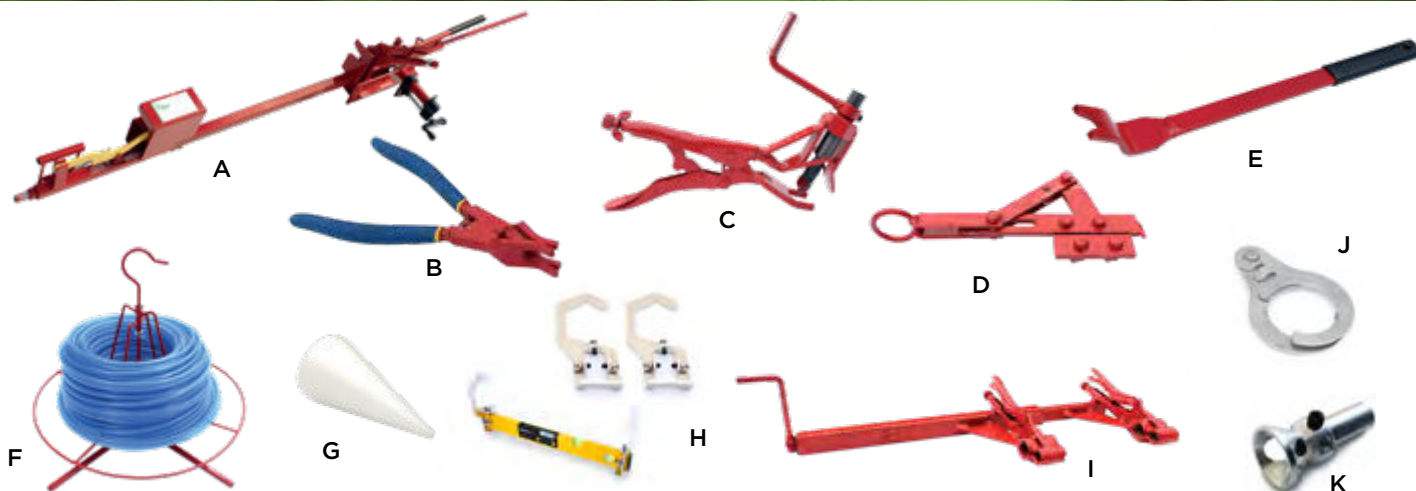

A - PRUNO RAPIDO-DROP WITH TUBING CUTTER	CODE
3/16", 24" to 40"	TU525-7170001XX
5/16", 24" to 40"	TU525-717000XX
3/16", 28" to 48"	TU525-7170031XX
5/16", 28" to 48"	TU525-717003XX

B - PRUNO SPOUT REDUCER EXTRACTOR	CODE
7/16"	TU444-000000XX
5/16"	TU444-000005XX

C - PRUNO HOLE PUNCH	CODE
5/16" (Yellow)	TU425-000005XX
3/8" (Black)	TU425-000006XX
7/16" (Blue)	TU425-000007XX
15/32" (Green)	TU425-000015XX
31/64" (Red)	TU425-000031XX

D - PRUNO WIRE PULLER	CODE
Wire tension grip 9"	TU436-071576XX
Wire tension grip 11"	TU436-071571XX

E - PRUNO SPOUT REMOVER	CODE
Light 15" for 5/16" & 7/16"	TU443-190507PL

F - PRUNO SPOOLERS	CODE
Pruno tubing reel without base	TU446-000000XX
Pruno base for tubing reel	TU447-000001XX
Vertical reel to be suspended	TU453-000000XX
Pruno horizontal wire spooler	TU575-000000XX

PRUNO MISCELLANEOUS TOOLS	CODE
G - Pruno threaded cone 1/4"	TU456-000005XX
Holder for right-hand drill	TU478-071936XX
H - Set hook holder line level for mainline 3/4" to 3" to 3"	TU551-071902XX
Spring for compact insert tool	TU439-000000XX

I - PRUNO MAINLINE INSTALLATION TOOLS	CODE
Pruno mainline installation tool 3/4" and 1"	TU445-001216XX
Pruno mainline installation tool 1" and 1 1/4"	TU445-001620XX
Pruno mainline installation tool 1 1/4" and 1 1/2"	TU445-002024XX
Pruno mainline installation tool 1 1/2" and 2"	TU445-002432XX
Pruno mainline installation tool 3/4" to 1 1/2" (kit)	TU445-001224XX

J - MAINLINE WIRING HOOK FOR ALIGN MAINLINE	CODE
0 to 1 1/4" stainless steel	TU555-071927XX
0 to 1 1/4" aluminium	TU555-071926XX
0 to 2" stainless steel	TU555-071928XX
0 to 2" aluminium	TU555-071925XX

K - PRUNO BIT STOPPER	CODE
15/64"	TU465-719102XX
1/4"	TU465-719103XX
17/64"	TU465-719104XX
9/32"	TU465-719105XX
19/64"	TU465-719106XX
5/16"	TU465-719107XX

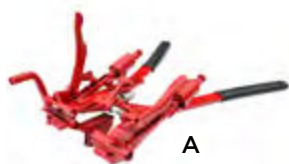

A

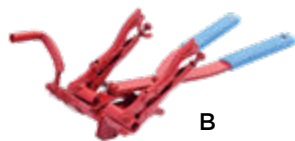

B



C



D

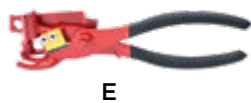

E



F



I



J



K



G



H



L



M

SCAN THE QR CODE
to discover our complete variety

ELAPIERRE.COM
Online Store

PRUNO TUBING INSTALLATION TOOL	CODE
A - 5/16" Pruno tubing installation auto-tension	TU428-000000XX
B - Pruno light installation tool with 3/16" jaw and cutter	TU528-711081XX
C - Pruno light installation tool with 3/16" jaw	TU528-711091XX
Plier - tubing installation "pruno" red with cutter w/o flaring tool	TU428-071106XX
Pruno installation plier, automatic calibratable pressure for 5/16" tubing. (without cutter or flaring device)	TU528-071112XX
Plier - installation Pruno light econo with out cutter and flaring tool	TU528-071109XX

LOAC TOOLS	CODE
I - Universal spout remover 15" for 5/16" & 7/16"	TU443-150507NX
I - Universal spout remover 22,5" for 5/16" & 7/16"	TU443-220507NX
I - Universal spout remover 30" for 5/16" & 7/16"	TU443-300507NX
I - Universal spout remover 40" for 5/16" & 7/16"	TU443-400507NX
J - Tapping hammer, double sided	TU440-000005XX
Tapping spout remover 12-2	TU440-120210XX

PRUNO REPAIR TOOL	CODE
D - Pruno insertion tool with lateral cutter	TU429-000000XX
E - Pruno tubing installation tool lateral cutter and flaring tool	TU430-000000XX
F - Pruno tubing cutter PRO 2 4 functions	TU536-071209XX
Pruno denuder PRO 2 plier without cutter	TU536-071211XX
G - Pruno compact insert tool with vise-grip and cutter	TU539-071065XX
H - Pruno compact insert tool with vise-grip without cutter	TU539-071060XX
Pruno insertion plier with lateral cutter for angle spouts (30° to 115°)	TU429-071067XX
Pruno insertion plier with 3/16" jaws, without cutter or flaring device	TU429-710506XX
Plier - flow-stopper, long nose and automatic tensioning	TU411-071919XX
Plier - flow-stopper, adjustment screw	TU411-071921XX

LOAC TOOLS	CODE
K - Side tie adjuster 20"	TU492-000020A1
K - Side tie adjuster 30"	TU492-000030A1
L - Multifunctions plier	TU530-000000XX
Ultra light 3/16" installation plier	TU423-600003A1
M - Ultra light 5/16" installation plier	TU423-600005A1

Several other PRUNO tools are available in store, please consult your distributor.



PVC40 GUILLOTINE VALVE	CODE
1"	VA006-001616P2
1 1/2"	VA006-002424P2
2"	VA006-003232P2
3"	VA006-004848P2



PVC40 LINE SPRING LOADED CHECK VALVE	CODE
1/2"	VA007-000808P2
3/4"	VA007-001212P2
1"	VA007-001616P2
1 1/4"	VA007-002020P2
1 1/2"	VA007-002424P2
2"	VA007-003232P2



SCAN THE QR CODE
to discover our complete variety

Plastic and stainless quick couplers



Grey PVC and white PVC40



ELAPIERRE.COM
Online Store



SS MAINLINE COUPLINGS KIT	CODE
Couplings kit SS 3/4"	TU105-001212S2
Couplings kit SS 1"	TU105-001616S2
Couplings kit SS 1 1/4"	TU105-002020S2
Couplings kit SS 1 1/2"	TU105-002424S2
Couplings kit SS 2"	TU105-003232S2

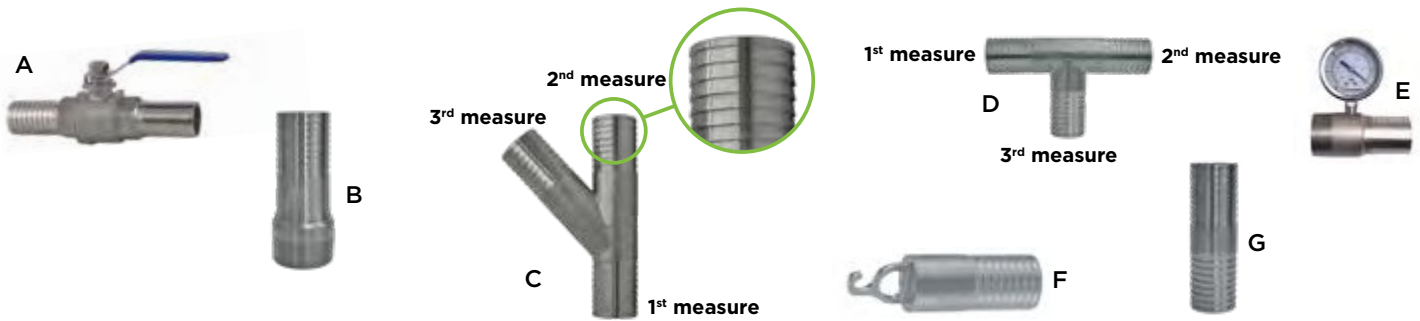

A - BALL VALVE (INS X INS)	CODE
3/4"	VA051-001212S2
1"	VA051-001616S2

B - ADAPTOR (MPT X INS)	CODE
1/2"	TU100-000808S2
3/4"	TU100-001212S2
1"	TU100-001616S2
1 1/4"	TU100-002020S2
1 1/2"	TU100-002424S2
1" x 3/4"	TU100-001612S2
1 1/4" x 1"	TU100-002016S2
1 1/2" x 1 1/4"	TU100-002420S2
2" x 1 1/2"	TU100-003224S2
2"	TU100-003232S2
3"	TU100-804848S2

C - Y	CODE
3/4"	TU102-121212S2
1" x 3/4" x 3/4"	TU102-161212S2
1" x 1" x 3/4"	TU102-161612S2
1"	TU102-161616S2
1 1/4" x 1" x 1"	TU102-201616S2
1 1/4" x 1 1/4" x 3/4"	TU102-202012S2
1 1/4" x 1 1/4" x 1"	TU102-202016S2
1 1/4"	TU102-202020S2
1 1/2" x 1" x 1"	TU102-241616S2
1 1/2" x 1 1/4" x 1 1/4"	TU102-242020S2
1 1/2" x 1 1/2" x 1"	TU102-242416S2
1 1/2" x 1 1/2" x 1 1/4"	TU102-242420S2
1 1/2"	TU102-242424S2
2" x 2" x 1 1/4"	TU102-323220S2
2" x 2" x 1 1/2"	TU102-323224S2
2"	TU102-323232S2
3"	TU102-484848S2

D - TEE	CODE
3/4"	TU103-121212S2
1" x 1" x 3/4"	TU103-161612S2
1"	TU103-161616S2
1 1/4" x 1 1/4" x 3/4"	TU103-202012S2
1 1/4" x 1 1/4" x 1"	TU103-202016S2
1 1/4"	TU103-202020S2
1 1/2" x 1 1/2" x 1"	TU103-242416S2
1 1/2"	TU103-242424S2
2"	TU103-323232S2

E - ADAPTOR WITH HOLE (DIAL NOT INCLUDED)	CODE
Adaptor 1" MPT x INS, side hole 1/4" FPT	TU157-161604S2
Adaptor 1 1/4" x 1" MPT x INS, side hole 1/4" FPT	TU157-201604S2
Adaptor 1 1/4" MPT x INS, side hole 1/4" FPT	TU157-202004S2

F - SS END-PLUG WITH HOOK	CODE
3/4"	TU820-000012SS
1"	TU820-000016SS
1 1/4"	TU820-000020SS
1 1/2"	TU820-000024SS
2"	TU820-000032SS

G - COUPLING	CODE
1/2"	TU101-000808S2
3/4"	TU101-001212S2
1"	TU101-001616S2
1 1/4"	TU101-002020S2
1 1/2"	TU101-002424S2
2"	TU101-003232S2
1" x 3/4"	TU101-001612S2
1 1/4" x 1"	TU101-002016S2
1 1/2" x 1 1/4"	TU101-002420S2
2" x 1 1/2"	TU101-003224S2
3"	TU101-004832S2

Other sizes available

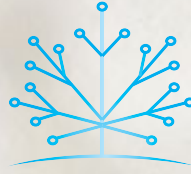

DATACER

sugarbush automation



ALWAYS ON THE LOOKOUT

THE MOST POWERFUL MONITORING AND REMOTE CONTROL SYSTEM

A CLEAR VISION OF **MAPLE SUGARING 4.0**

The DATACER team is dedicated to the development of maple sugaring information technologies.

Our mission is to communicate data on your sugar bush's main performance indicators locally or remotely, and in real time. DATACER enables optimal management of your workforce and priorities through access to essential sugar bush information.

Moreover, we offer remote control and pumping station equipment automation to make your life easier.

DETECTION AND **QUICK REACTION TIME**

The DATACER system detects productivity losses in real time and allows you to respond quickly and precisely where needed.

- Save time and energy.
- Reduce the impact of seasonal stress.
- Ensure a better quality of life.
- No guessing; target the leak and fix it.
- No more overflowing sap tanks.
- Get a quick return on your investment.
- Remotely control and automate your pumping stations.



DATACER Base



Vacuum transmitter (3 main lines)

Long-range transmitters can cover up to **3 MILES** of distance*

DATACER MONITORING SYSTEM	CODE
DATACER base, without antenna. Includes: cable, screen, keyboard, mouse and battery backup (UPS)	SM100-020002NX
DATACER mobile	SM100-000019XX
Vacuum transmitter (1 main line), D batteries included	SM100-010001XX
Vacuum transmitter (2 main lines), D batteries included	SM100-020001XX
Vacuum transmitter (3 main line), D batteries included	SM100-030001XX
Signal repeater, 3 D batteries included	SM100-000006XX

* In ideal field conditions. The communication depends on field topography, vegetation density and transmitters height.



A combined transmitter can measure a combination of several parameters at the same time (tank level, pressure or vacuum). For all transmitters that can measure pressure, please choose from one of the pressure sensors options listed on page 22.

COMBINED MULTI-FUNCTION TRANSMITTER - WITHOUT ANTENNA		PRESSURE OPTION	OPTION ANTENNA	CODE
Transmitter P	(pressure option)	1, 2, 3, 4, 5 ou 6	A, B, C	SM100-000011P
Transmitter PP	(2 pressure options)	1, 2, 3, 4, 5 ou 6	A, B, C	SM100-000011PP
Transmitter PPP	(3 pressure options)	1, 2, 3, 4, 5 ou 6	A, B, C	SM100-000011PPP
Transmitter PV	(pressure option, 1 vacuum)	1, 2, 3, 4, 5 ou 6	A, B, C	SM100-000011PV
Transmitter PPV	(2 pressure options, 1 vacuum)	1, 2, 3, 4, 5 ou 6	A, B, C	SM100-000011PPV
Transmitter PLL	(pressure option, 2 tank level by ultrasound)	1, 2, 3, 4, 5 ou 6	A, B, C	SM100-000011PLL
Transmitter PLV	(pressure option, 1 tank level by ultrasound, 1 vacuum)	1, 2, 3, 4, 5 ou 6	A, B, C	SM100-000011PLV
Transmitter LV	(1 tank level by ultrasound, 1 vacuum)	-	A, B, C	SM100-000011LV
Transmitter LLV	(2 tank level by ultrasound, 1 vacuum)	-	A, B, C	SM100-000011LLV

OPTION - EXTERNAL ANTENNA		CODE
Option A (standard)	Adaptor with whip antenna	SM300-000905KT
Option B	Omnidirectionnal antenna & cable 30'	SM300-030906KT
Option C	Omnidirectionnal antenna & cable 50'	SM300-050906KT

BATTERY	CODE
Battery (3) D12 PROCELL for transmitter including 1 silica gel moisture 10 gr	DV955-000012KT



MODULATION AND EMERGENCY STOP VALVE

As an option on the DATA CER station, this valve creates a restriction between your extractor and your pump to modulate the vacuum level. The modulation is either according to the external temperature or according to the vacuum set points determined. Improve the performance of your sugar bush and prevent premature freezing of your master lines through efficient vacuum management!

You can also add a float on your extractor that will cause this valve to close in case of overflow. This will add superior protection to your vacuum pump. If the extractor is located in a pumping station without a vacuum pump, then this allows you to only isolate that extractor if it overflows. Therefore, you will prevent the external vacuum hose from filling with water and then freezing. In addition, you will not penalize the vacuum supply of other areas.

MODULATION AND EMERGENCY STOP VALVE		CODE
Valve only		SM312-010032SXV
Emergency stop	(float, body 6") for vacuum modulation valve on horizontal extractor	SM512-960075XX
Emergency stop	(level switch) for vacuum modulation valve on vertical extractor	SM512-200075XX

CONTROL YOUR PUMP-STATION

Equipment control can be done manually remotely by the user or automatically based on temperature, pressure or other parameters.

- Vacuum pump Start / Stop
- Sap pump Start / Stop
- Draining valve Open / Close
- Measure the vacuum level at the extractor to benefit from the differential measurement
- Sap Extractor vacuum level modulation
- Close sap Extractor vacuum level modulation valve In case of extractor flooding
- Tank level monitoring
- R.O. Feed pump pressure monitoring after pre filters
- Pump station Indoor and outdoor temperature monitoring
- Real time operating status monitoring of: vacuum pump, sap pump and draining valve



DATA CER STATION	CODE
DATA CER station, W/O antenna * Requires antenna option (B or C) see page 30 ** Antenna option A for sugar shack station only	SM100-000012XX

DATA CER STATION (AVAILABLE OPTIONS)	CODE
Ultrasound sensor for one SS tank	SM312-000112KT
Pressure sensor 0-150 PSI (kit)	SM312-025100KT
Pressure sensor 0-300 PSI (kit)	SM312-027100KT
Water pump control by electrode, 2 HP max, 240V for one pump (electrode 60")	SM412-013260KT
Water pump control by electrode, 2 HP max, 240V for one pump (electrode 96")	SM512-013260KT
Water pump control by electrode, 3 HP max, 240V for one pump (electrode 60")	SM412-014860KT
Water pump control by electrode, 3 HP max, 240V for one pump (electrode 96")	SM512-014860KT
Water pump control by electrode, 5 HP max, 240V for one pump (electrode 60")	SM412-018060KT
Water pump control by electrode, 5 HP max, 240V for one pump (electrode 96")	SM512-018060KT
Relay for starting vacuum pump by magnetic (1 pump)	SM312-011002KT
Relay for starting vacuum pump by magnetic (2 pumps)	SM312-021002KT
1/2" air intake valve for DATA CER station	SM312-080005XX
1" drainage valve for DATA CER station	SM312-160006XX
Pressure sensor 0-34', cable 25' & connection 1/4" MPT	SM312-021100KT
Level sensor by pressure 0-100", cable 30' & connection 1/4" MPT	SM312-000100KT
Submersible level sensor 0-10' & cable 50'	SM312-015260KT
Submersible level sensor 0-10' & cable 100'	SM312-030260KT



DATACER GATEWAY NEW

Add new remote sites and increase the speed of remote control of your pumping station equipment.

DATACER GATEWAY	CODE
Datacer station Gateway, no radio, no connection	SM100-000017XX
Radio option for Datacer Gateway	SM317-100000XX
Station connection option for Datacer Gateway	SM317-200000XX
Second station connection option for Datacer Gateway	SM317-200000XX

PRESSURE OPTION				OPTION	CODE
Pressure sensor 0-150 PSI	Cable 25'	Connection 1/4" MPT		1	SM300-025150KT
Level sensor by pressure 0-100"	Cable 30'	Connection 1/4" MPT		2	SM300-000100KT
Pressure sensor 0-34'	Cable 25'	Connection 1/4" MPT		3	SM300-021100KT
Submersible level sensor 0-10'	Cable 50'			4	SM300-015260KT
Pressure sensor 0-300 PSI	Cable 25'	Connection 1/4" MPT		5	SM300-027100KT
Submersible level sensor 0-10'	Cable 100'			6	SM300-030260KT



MOBILE DATACER NEW

Visualize system data in the field in the absence of cellular network.



Handheld mobile Datacer	SM100-000019XX
-------------------------	-----------------------

TRANSMITTER FOR TANK LEVELS			OPTION ANTENNE	CODE
Transmitter I	1 tank level by ultrasound	Without antenna	A, B, C	SM100-010010NX
Transmitter II	2 tank levels by ultrasound	Without antenna	A, B, C	SM100-020010NX
Transmitter III	3 tank levels by ultrasound	Without antenna	A, B, C	SM100-030010NX

WATER METER FOR DATACER STATION	MINIMUM FLOW (USG/MIN)	OPTIMAL FLOW (USG/MIN)	*MAXIMAL FLOW (USG/MIN)	CODE
	D1	D2	D3	
1 1/2"	0,7	1,1	70	SM312-020200KT
2"	1,1	1,8	110	SM312-030200KT

Margin of error % Less than D2 = 5% Between D2 and D3 = 2% Greater than D3 = 5%

*The water meter may break if the flow rate is greater than or equal to the maximum flow rate indicated in this table.



LONGEVITY & AGILITY MASTERY OF WATER

The most complete line of sap extractors
to perfectly suit all needs.

BERNARD AND LAPIERRE TWO NAMES ONE FAMILY

The launch of the first Lapierre maple sap extractors triggered the company manufacturing capabilities in the late 70's. Donald Lapierre designed and built the first reliable mechanical extractor on the market. Proud of our complete range of extractors, we emphasize on quality and simplicity of operation. In 2005 we acquired the sugarbush equipment manufacturer Gilles Bernard Maple Equipment to offer another interesting alternative to our customers. We kept the technical principles that made them famous but added key Lapierre Equipment manufacturing features.

SPECIFICATIONS

- Stainless steel frames, clips and fasteners;
- Standardized parts that fit on all our extractors;
- Easier than ever to take apart for cleaning and lubricating;
- All parts are CNC machined in house for a perfect fit every time;
- Manifold inlet sizes and position can be customized upon request (ask your dealer).



12" x 36" HTC

TWIN CONTINUOUS VACUUM EXTRACTOR (VTCV AND HTC)

These extractors provide two bellies operating independently as a single extractor. If one stops operating, the other belly will still operate thus retaining 50% of its capacity. To enjoy this benefit, install a model that offers twice the collection capacity you need.

Sap inlet
5 x 1"

↑
14 1/2"

↓
Sap outlet
2 x 2"



8" X 8" X 14" VTCV EXTRACTOR

Sap inlet
7 x 1"

↑
22 1/4"

↓
Sap outlet
2 x 3"



12" X 36" HTC EXTRACTOR

Sap inlet
(20" x 36") 11 x 1/4"

↑
(20" x 36")
26 1/2"

↓
Sap outlet
(20" x 36") 2 x 3"



20" X 36" HTC EXTRACTOR

DIMENSION	TYPE	VALVE SYSTEM	O'RING KIT	DESCRIPTION	CODE
8" x 8" x 14"	VTCV	BERNARD	2 x D	Vacuum feed 1-1/2" 6" manifold	Maximum of 1500 taps 223-M6-JVC
12" x 36"	HTCV	LAPIERRE	2 x B	Vacuum feed 2" 6" manifold	Maximum of 3700 taps EX021-361236XX
12" x 36"	HTCV	BERNARD	2 x F	Vacuum feed 2" 6" manifold	Maximum of 3700 taps 218-JVC
20" x 36"	HTCV	BERNARD	2 x G	Vacuum feed 2" 6" manifold	Maximum of 12 000 taps 220-2-JVC



20" x 41" electric

ELECTRIC EXTRACTOR WITH INTERNAL PUMP

Available with one or two pumps* (internal independent) this extractor is the ultimate in continuous vacuum because it never releases its vacuum.

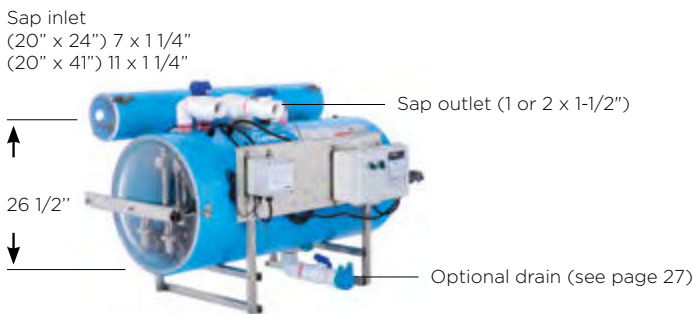

20" X 41" EXTRACTOR

IMPROVED MODEL



LAPIERRE 12"X36" EXTRACTEUR

DIMENSION	PUMP	VERTICALS EXTRACTORS				CODE
12" x 36"	1 pump TYPE C	1 control	Vacuum feed 2"	6" X 12" manifold	With electric float and jog button connection included (Option electrode 5)	EX110-001236XX

DIMENSION	PUMP	HORIZONTALS EXTRACTORS				CODE
20" x 24"	1 pump TYPE C	1 control	Vacuum feed 3"	6" x 27" manifold	(Option electrode 2)	EX125-012024NX
20" x 24"	2 pumps TYPE C	1 control	Vacuum feed 3"	6" x 27" manifold	(Option electrode 2)	EX125-022024NX
20" x 41"	1 pump TYPE C, D, E, or H	1 control	Vacuum feed 3"	6" x 42" manifold	(Option electrode 2)	EX125-012041NX
20" x 41"	1-2 pumps TYPE C, D, E, or H	2 controls	Vacuum feed 3"	6" x 42" manifold	(Option electrode 4)	EX125-022041NX

Pumps, draining kit and electrodes pump control not included, see page 27.



20" x 41" DHS

ELECTRIC EXTRACTOR WITH INTERNAL PUMP

Now available with one, two, three or four independent internal pumps this extractor is the ultimate in continuous vacuum because it never releases its vacuum.

Sap Inlet on demand only

31 1/4"

Sap outlet 3 or 4 x 1 1/2"



LAPIERRE 20" X 41" DHS

Sap Inlet (20" x 24") 7 x 1 1/4" (20" x 41") 11 x 1 1/4"

26 1/2"

Sap outlet (20" x 24") 1 x 1 1/2" (20" x 41") 1 ou 2 x 1 1/2" Flapper drain included



20" X 24" EXTRACTEUR HYBRIDE

DIMENSION	PUMP	DESCRIPTION			CODE
20" x 41"	1 pump TYPE C, D, E or H	Electrodes control	Vacuum feed 3"	Double stacked 20" x 41" tanks	EX129-012041XX
20" x 41"	1-2 pumps TYPE C, D, E or H	Electrodes control	Vacuum feed 3"	Double stacked 20" x 41" tanks	EX129-022041XX
20" x 41"	1-3 pumps TYPE C, D, E or H	Electrodes control	Vacuum feed 3"	Double stacked 20" x 41" tanks	EX129-032041XX
20" x 41"	1-4 pumps TYPE C, D, E or H	Electrodes control	Vacuum feed 3"	Double stacked 20" x 41" tanks	EX129-042041XX
SINGLE TANK WITHOUT MANIFOLD					
20" x 41"	1 pump TYPE C, D, E or H	1 control	Vacuum feed 3"	Single 20" x 41" tank (Option electrode 2)	EX141-012041XX EX325-013260KN

Draining kit not available for the models above. Electrodes pump control not included on EX141-012041XX, see page 27.

DIMENSION	PUMP	VALVE SYSTEM	O-RING KIT	DESCRIPTION		CODE
20" x 24"	1 pump TYPE C	BERNARD	G	Vacuum feed 2"	Manifold 6" x 27" (Option electrode type 2)	EX126-012024BE
20" x 41"	1 pump TYPE C, D, E or H	BERNARD	J	Vacuum feed 2"	Manifold 6" x 42" (Option electrode type 2)	EX126-012041BE

Sap inlet holes on demand. Pump not included, see page 27.



(C-D-E-H)

Pompe submersible (DEEP WELL)



DRAINING KIT	CODE
draining kit on single electric horizontal extractor 20" x 24" & 20" x 41" for submersible pump	EX225-323204RT

TYPE	SUBMERSIBLE PUMP (DEEP WELL) FOR EXTRACTOR		CODE
C	20 GPM 1/2 HP	20 VAC = 20 GAL to 30 PSI, 0 GAL to 50 PSI	PM152-082005XX
		25 VAC = 20 GAL to 30 PSI, 0 GAL to 47 PSI	
		27 VAC = 15 GAL to 30 PSI, 0 GAL to 45 PSI	
		28 VAC = 6 GAL to 30 PSI, 0 GAL to 43 PSI	
D	25 GPM 1 HP	20 VAC = 35 GAL to 30 PSI, 0 GAL to 85 PSI	PM162-162506XX
		25 VAC = 28 GAL to 30 PSI, 0 GAL to 80 PSI	
		27 VAC = 24 GAL to 30 PSI, 0 GAL to 75 PSI	
		28 VAC = 11 GAL to 30 PSI, 0 GAL to 70 PSI	
E	25 GPM 2 HP	20 VAC = 31 GAL to 30 PSI, 0 GAL to 140 PSI	PM162-322510XX
		25 VAC = 24 GAL to 30 PSI, 0 GAL to 135 PSI	
		27 VAC = 22 GAL to 30 PSI, 0 GAL to 130 PSI	
		28 VAC = 12 GAL to 30 PSI, 0 GAL to 135 PSI	
H	60 GPM 2 HP	20 VAC = 50 GAL to 30 PSI, 0 GAL to 72 PSI	PM162-603201XX
		25 VAC = 45 GAL to 30 PSI, 0 GAL to 70 PSI	
		27 VAC = 35 GAL to 30 PSI, 0 GAL to 65 PSI	
		28 VAC = 20 GAL to 30 PSI, 0 GAL to 60 PSI	

*1 psi = 2.3 feet of elevation. (Do not forget to calculate the friction of the tube when calculating your pumps)
The above pumps are 240V, 1 HP. Possibility to have 575V, 3 HP, type D, E and H (contact Lapierre Equipment).

TYPE	ELECTRODES PUMP CONTROL OPTION FOR ELECTRIC EXTRACTOR ON NEW EXTRACTOR PURCHASE ONLY	CODE
2	2 HP max, 240V. for 1 pump on 20" electric horizontal extractor	EX325-013260KN
	2 HP max, 575V. for 1 pump on 20" electric horizontal extractor	EX425-013260KN6
4	2 HP max, 240V. for 2 pumps on 20" electric horizontal extractor	EX325-023260KN
	2 HP max, 575V. for 2 pumps on 20" electric horizontal extractor	EX425-023260KN6
5	2 HP max, 240V. for 1 pump on 12" x 36" electric vertical extractor	EX510-013260KT

ELECTRODES PUMP CONTROL OPTION FOR ELECTRIC EXTRACTOR EXTRACTOR MODIFICATION (LABOR NOT INCLUDED)		CODE
2 HP max, 240V. for 1 pump on 20" electric horizontal extractor		EX225-013260KN
2 HP max, 240V. for 2 pumps on 20" electric horizontal extractor		EX225-023260KN
2 HP max, 240V. for 1 pump on 12" x 36" electric vertical extractor		EX310-013260KT



12" x 36" DH

DOUBLE MECHANICAL EXTRACTOR (DV AND DH)

In these double extractors each tank operates in turn. While one is emptied of its sap, the other begins its filling cycle and vice versa. This process offers a higher collection capacity than a single extractor but less capacity compared to a twin continuous vacuum.

Sap inlet
5 x 1"



Sap outlet
2 x 2"

Sap inlet
7 x 1"



Sap outlet
2 x 2"

Sap inlet
7 x 1"



Sap outlet
2 x 2"

Sap inlet
(20" x 36") 11 x 1 1/4"
(20" x 48")
upon order



Sap outlet
(20" x 36") 2 x 3"
(20" x 48") 2 x 6"

8" X 8" X 14" DV EXTRACTOR

12" X 36" DH EXTRACTOR

12" X 12" X 18" DV EXTRACTOR

20" X 36" DH EXTRACTOR (2")

DIMENSION	TYPE	VALVE SYSTEM	O'RING KIT	DESCRIPTION			CODE
8" x 8" x 14"	DV	BERNARD	D	Vacuum feed 1"	Manifold 6"	Maximum of 1000 taps	223-M6
12" x 36"	DH	BERNARD	E	Vacuum feed 1-1/2"	Manifold 6"	Maximum of 2500 taps	218
12" x 12" x 18"	DV	LAPIERRE	2 x B	Vacuum feed 1-1/2"	Manifold 6"	Maximum of 3000 taps	EX005-121806XX
12" x 12" x 18"	DV	BERNARD	E	Vacuum feed 1-1/2"	Manifold 6"	Maximum of 3000 taps	213
20" x 36"	DH	BERNARD	H	Vacuum feed 2"	Manifold 6"	Maximum of 8000 taps	220



BERNARD 12" x 36" TCV-HRS

TWIN CONTINUOUS VACUUM REVERSE SLOPE EXTRACTOR (TCV-HRS AND TCV-VRS)

These new types of reverse slope extractors now operate on the principle of twin continuous vacuum. It features 2 independent bellies operating like a single extractor while remaining a reverse slope. The necessary air leak for the proper operation of a reverse slope is now reduced and controlled. A reverse slope extractor TCV-HRS allows to raise the sap up to 20 ft @ 25 in/Hg or to 15 ft @ 20 in/Hg. The sap outlet and the vacuum feed of the reverse slope must be hooked to the manifold of the receiving extractor at the hilltop.

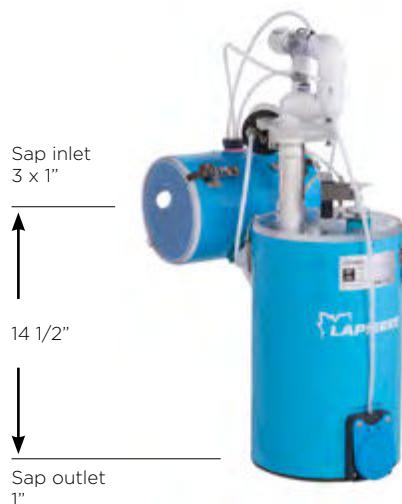

SINGLE BERNARD REVERSE SLOPE

This single reverse slope is used to push sap up toward an extractor or a transfer tank at a maximum height of 15 ft @ 20 in/Hg or 20 ft @ 25 in/Hg. It will drain itself automatically when there is no more vacuum fed to it. Unlike a conventional reverse slope extractor, it only needs one pipe for the vacuum and sap outlet.



8" X 8" X 14" TVC-VRS EXTRACTOR

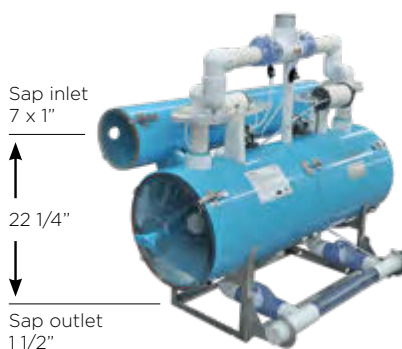

12" X 36" TVC-HRS EXTRACTOR

DIMENSION	TYPE	VALVE SYSTEM	O'RING KIT	DESCRIPTION	CODE
8" X 14"	SV-VRS	BERNARD	D	Vacuum feed 1" 6" manifold	217-M6-PI
8" x 8" x 14"	TCV-VRS	BERNARD	2 x D	Vacuum feed 2 x 1" 6" manifold	217-M6-JVC-PI
12" x 36"	TCV-HRS	BERNARD	2 x E	Vacuum feed 1 1/2" 6" manifold	218-JVC-PI

* The maximum amount of tap on a reverse slope extractor is related to the diameter and length of the drain pipe and the slope. Contact your Lapierre sales representative for an adequate selection.



20" x 24" SH

SINGLE MECHANICAL EXTRACTOR (SV AND SH)

The simplicity of operation of these single mechanical extractors makes them economic and reliable. When the sap level pushes the float up, the vacuum is cut from the belly and the sap is released.

Sap inlet
3 x 1"



Sap outlet 2"

8" X 14" SV EXTRACTOR

Sap inlet
4 x 1"



Sap outlet 2"

12" X 18" SV EXTRACTOR

Sap inlet
7 x 1"



Sap outlet 3"

12" X 24" SH EXTRACTOR

Sap inlet
7 x 1 1/4"



Sap outlet 6"

20" X 24" SH 3" EXTRACTOR

DIMENSION	TYPE	VALVE SYSTEM	O'RING KIT	DESCRIPTION			CODE
8" x 14"	SV	BERNARD	D	Vacuum feed 1"	6" manifold	Maximum of 500 taps	217-M6
12" x 18"	SV	LAPIERRE	B	Vacuum feed 1 1/2"	6" manifold	Maximum of 1200 taps	EX004-121806XX
12" x 18"	SV	BERNARD	F	Vacuum feed 1 1/2"	6" manifold	Maximum of 1200 taps	216
12" x 24"	SH	LAPIERRE	B	Vacuum feed 1 1/2"	6" manifold	Maximum of 1500 taps	EX001-271224XX
12" x 24"	SH	BERNARD	F	Vacuum feed 1 1/2"	6" manifold	Maximum of 1500 taps	210
20" x 24"	SH	BERNARD	G	Vacuum feed 2"	6" manifold	Maximum of 5000 taps	215



A

A - SAP LADDER AIR INJECTOR	CODE
Injects air in the system to move the sap up the ladder.	512

SELF CLEANING SPRINKLER OPTION
 20" sap extractor self cleaning sprinklers. Only available on the superior tank of a double staked extractor.

KIT SPRINKLER & CONNECTION	AVAILABLE WITH OPTION	CODE
Kit sprinkler & connection to the internal pump for manual cleaning, pump not included (on new extractor)	EX171-000020XX	EX071-000020PX
Kit sprinkler & connection to a hose for manual cleaning, hose not included (on new extractor)	EX171-000020XX	EX071-000020XX



Retrofit on existing extractors is possible. See your Lapierre dealer.

MISCELLANEOUS	CODE
Replacement sprinkler only for cleaning system	EX271-000011XX
Control kit for automatic cleaning, sprinkler not included (on new extractor)	EX171-000020XX



B

B - SAP RECOVERY DEVICE	CODE
This accessory is used to recover the sap in the bottom of a drainage tank to avoid sap loss. The ball floats allowing the sap to be siphoned by the vacuum coming from the extractor. Once the tank is emptied the ball comes down and blocks the inlet. (connected under the manifold vacuum gage).	EX107-000000XX

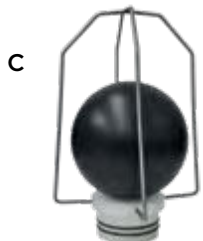

C

C - SAP TANK REVERSE SLOPE (FITS ON LAPIERRE STORAGE TANKS ONLY)	CODE
Used to siphon sap from a tank to a sap extractor at a maximum height of 15 ft @ 20 in/Hg and 20 ft @ 25 in/Hg automatically drains the line back to the tank when there's no more vacuum.	BA509-000024XX
	BA509-000032XX



D
 Sap tank reverse slope
 Illustration:
 with valve

D - SAP TANK REVERSE SLOPE	CODE	
	Automatic vacuum	Without draining valve
Used to siphon sap from a tank to a sap extractor at a maximum height of 15 ft @ 20 in/Hg and 20 ft @ 25 in/Hg. Includes automatic vacuum draining valve.	520	520-S



VACUUM POWERED SAP PISTON PUMP

Unique to Lapierre Equipment, these pumps allow sap to be pumped a great distance without electricity. Proven reliability since 1996.

transfer tank and manifold

SCAN THE QR CODE to discover our complete variety



ELAPIERRE.COM
Online Store



U-CUP	CODE
8" Replacement U-cup not included (for all sizes)	DV200-000875XX

SINGLE ACTION WITH SINGLE VACUUM CYLINDER	CODE
300 USG/Hr @ 66'/elevation or 30 psi @ 20 in/Hg	PM015-000101XX
Replacement seal kit	DV200-001001KT

SINGLE ACTION WITH DUAL VACUUM CYLINDER	CODE
225 USG/Hr @ 132'/elevation or 60 psi @ 20 in/Hg	PM015-000102XX
Replacement seal kit	DV200-002001KT

DUAL ACTION WITH SINGLE VACUUM CYLINDER	CODE
450 USG/Hr @ 66'/elevation or 30 psi @ 20 in/Hg	PM015-000201XX
Replacement seal kit	DV200-001002KT

DUAL ACTION WITH DUAL VACUUM CYLINDER	CODE
340 USG/Hr @ 132'/elevation or 60 psi @ 20 in/Hg	PM015-000202XX
Replacement seal kit	DV200-002002KT



1" PUMP CONNECT KIT	CODE
With SS spring valve	PM405-010016XX

LED KIT	CODE
For extractor	EX080-000001XX





KIT	CODE
Pressure relief adaptor kit	PM010-00000SS



BANJO FILTER	CODE
3/4"	PM061-001212XX
1"	PM061-001616XX
1 1/4"	PM061-002020XX
1 1/2"	PM061-002424XX
2"	PM061-003232XX

EMERGENCY STOP VALVE FOR EXTRACTOR WITH 1 1/2" & 2" CONNECTION AND FLOAT ON 1" MPT ADAPTOR

This system prevent sap overflow from the sap extractor shutting off the vacuum feed by the signal of an adjustable float located inside the extractor. The valve will reopen ten seconds after the float signal is lost. The valve must be installed vertically on the upmost portion of extractor vacuum feed.



SCAN THE QR CODE
to discover our complete variety

Lapierre high pressure transfer pump



Goulds pumps



ELAPIERRE.COM
Online Store

EMERGENCY STOP VALVE	CODE
For extractor with 1 1/2" & 2" connection and float on 1" mpt adaptor	EX075-010032XX

EMERGENCY STOP OPTIONS	CODE
Emergency stop (float, body 6") for vacuum modulation valve on horizontal extractor	SM512-960075XX
Emergency stop (level switch) for vacuum modulation valve on vertical extractor	SM512-200075XX

THE VACUUM PUMP EVERY SUGARMAKER TALKS ABOUT, BUILT FOR HIGH VACUUM!



- Rotary claws dry pump;
- No friction;
- Air cooled, no water or oil;
- Pollution free clean operation;
- Simple construction yet robust;
- Minimal maintenance;
- Can operate via VFD;
- Very low electrical consumption;
- Very low noise operation.



PROGRESSIVE START VARIABLE SPEED DRIVE

- Can be hooked-up to any existing auto start and stop system;
- No need for external magnetic starter;
- Manual RPM adjustment;
- Progressive start to eliminate high power peaks;
- Convert single phase power to 3 phase;
- Electrical hook-up should be handled by a certified electrician.

BASE ON CASTERS (BUSCH VACUUM PUMP)	CODE
Base for 0040	PM420-004000D1
Base for 1102, 1142, 1144	PM420-110200D1
Base for 1252, 1322	PM420-125200D1

BASE ON CASTERS (BUSCH R5 MODEL)	CODE
Base for R0025, R0040	PM430-025040D1
Base for R0063, RA100	PM430-063100D1
Base for R0165, R0205, R0255 R0305	PM430-165305D1



FILTER IN WASHABLE FABRIC



SPARE AIR FILTER CARTRIDGE (BUSCH VACUUM PUMP)	CODE
MM1144, MV0040B, RA0025 and RA0040 pump	PM325-532002XX
MM1142, MM1102, RA0063 and RA0100 pump	PM325-532003XX
MM1252, MM1322, RA0165, RA0205, RA0255 and RA0305 pump	PM325-532004XX
RC0021 pump	PM325-532005XX

GEAR BOX OIL	CODE
VS150, 1 liter (BUSCH MINK VACUUM PUMPS)	PM327-164883XX

HOOKS LUBRICANT	CODE
500 ml (Busch vacuum pump)	PM428-034500ML



MINK BUSCH PUMP MV0040 12 SCFM @ 15" (MAX. : 28,7 IN/HG)	CODE
1.5 HP motor with variable speed 1.24KW, 1 HP, 220V Intake filter assembly and adaptor included	PM120-004001XX

BUSCH VACUUM PUMPS ARE AVAILABLE IN 3 DIRECT DRIVE CONFIGURATIONS:

Single phase motors with fixed speed. Three phase 230/460 or 575 volts, can use a variable frequency drive for energy consumption reduction up to 50%, and lower amp requirements to start the pump.

PUMP MM1144BV	29 SCFM @ 15" (MAX. : 28,5 PO/HG)	CODE
Single phase motor	220 Volts / 3 HP	PM120-114403XX
3 phase motor	230/460 V / 3 HP	PM121-114402XX
3 phase motor	575 V / 3 HP	PM121-114402AX
Progressive start control	1 HP 220 V to 3 HP 230 / 460 V	PM421-114402XX
Progressive start control	600 V 3 HP à 600V 3 HP	PM421-114403AX
Connection kit for progressive start	Miscellaneous parts	EL421-114400XX

PUMP MM1102BV	40 SCFM @ 15" (MAX. : 28,5 PO/HG)	CODE
Single phase motor	220 V / 5 HP	PM120-110205XX
3 phase motor	230/460 V / 5 HP	PM121-110203XX
3 phase motor	575 V / 5 HP	PM121-110203AX
Progressive start control	1 HP 220 V to 3 HP 230/460 V	PM421-110205XX
Progressive start control	575 V / 5 HP	PM421-110205AX
Connection kit for progressive start	Miscellaneous parts	EL421-114200XX

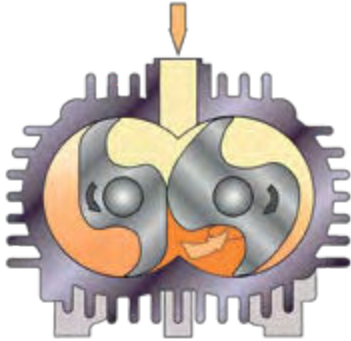

Includes exhaust flap, lubrication valve, intake filter. Electrical hook-up should be handled by a certified electrician. The connection kit for progressive start includes everything needed to connect the vacuum pump to the controller. Cable 8'.

PUMP MM1142BV	52 SCFM @ 15" (MAX.: 28,5 PO/HG)	CODE
Single phase motor	220 V / 7,5 HP	PM120-114207XX
3 phase motor	230/460 V / 7,5 HP	PM121-114204XX
3 phase motor	575 V / 7,5 HP	PM121-114204AX
Progressive start control	1 HP 220 V to 3 HP 230/460 V	PM421-114204XX
Progressive start control	600 V 3 HP to 600V 3 HP	PM421-114204AX
Connection kit for progressive start	Miscellaneous parts	EL421-114200XX

PUMP MM1252AV	83 SCFM @ 15" (MAX.: 27 PO/HG)	CODE
Single phase motor	220 V / 10 HP	PM120-125210XX
3 phase motor	230/460 V / 7,5 HP	PM121-125205XX
3 phase motor	575 V / 7,5 HP	PM121-125205AX
Progressive start control	1 HP 220 V to 3 HP 230/460 V	PM421-125205XX
Progressive start control	600 V 3 HP to 600 V 3 HP	PM421-125205AX
Connection kit for progressive start	Miscellaneous parts	EL421-125200XX

PUMP MM1322AV	100 SCFM @ 15" (MAX.: 25,5 PO/HG)	CODE
Single phase motor	220 V / 12,5 HP	PM120-132212XX
3 phase motor	230 / 460 V / 10 HP	PM121-132206XX
3 phase motor	575 V / 10 HP	PM121-132206AX
Progressive start control	1 HP 220 V to 3 HP 230/460 V	PM421-132206XX
Progressive start control	600 V 3 HP to 600 V 3 HP	PM421-132206AX
Connection kit for progressive start	Miscellaneous parts	EL421-132200XX

BUSCH R5

Since 1963, Busch Vacuum Technics has been manufacturing the most efficient and robust vacuum pumps in the industry. Being the first to manufacture and optimize oil-lubricated rotary vane pumps as we know them today, Busch R 5 vane pumps are still today considered the industry benchmark because of their robustness and high operational reliability. More than 3 million of R 5 vacuum pumps are now used worldwide for a variety of demanding industrial applications. Their high efficiency at low vacuum, their energy efficiency and the efficiency of the the exhaust box filtration system invented by Dr. Ing. Karl Busch make this pump a powerful and reliable equipment for maple producers who want to operate at low vacuum. Initially developed for the food industry, the Busch R 5 pumps has a high tolerance to water vapor, an optimal low energy consumption and air flow over the entire vacuum range.



Includes with BUSCH R5 Vacuum pump: exhaust flap, intake filter. Electrical hook-up should be handled by a certified electrician. The connection kit for progressive start includes everything needed to connect the vacuum pump to the controller. Cable 8'.

PUMP R0021 (OIL 2 L)	6 SCFM @ 15" (MAX.: 29,3 PO/HG)	CODE
Single phase motor	120 V / 1,2 HP	PM130-002101XX
Single phase motor	220 V / 1,2 HP	PM130-012101XX

PUMP R0025 (OIL 2 L)	9 SCFM @ 15" (MAX.: 29,9 PO/HG)	CODE
Single phase motor	110/220 V / 1,5 HP	PM130-002501XX
3 phase motor	230/460 V / 1,5 HP	PM131-002501XX
Progressive start control	220 V 1 HP to 230/460 V 3 HP	PM421-002501XX
Progressive start control	600 V 3 HP to 600 V 3 HP	PM421-006303AX
Connection kit for progressive start	Miscellaneous parts	EL421-114200XX

PUMP R0040 (OIL 2 L)	14 SCFM @ 15" (MAX.: 29,9 PO/HG)	CODE
Single phase motor	110/220 V / 2 HP	PM130-004002XX
3 phase motor	230/460 V / 2 HP	PM131-004002XX
Progressive start control	220 V 1 HP to 230/460 V 3 HP	PM421-006303XX
Progressive start control	600 V 3 HP to 600 V 3 HP	PM421-006303AX
Connection kit for progressive start	Miscellaneous parts	EL421-114200XX

PUMP R0063 (OIL 3 L)	23 SCFM @ 15" (MAX.: 29,9 PO/HG)	CODE
Single phase motor	220 V / 3 HP	PM130-006303XX
3 phase motor	230/460 V / 3 HP	PM131-006303XX
Progressive start control	220 V 1 HP to 230/460 V 3 HP	PM421-006303XX
Progressive start control	600 V 3 HP to 600 V 3 HP	PM421-006303AX
Connection kit for progressive start	Miscellaneous parts	EL421-114200XX

PUMP R0100 (OIL 3 L)	36 SCFM @ 15" (MAX.: 29,9 PO/HG)	CODE
Single phase motor	220 V / 5 HP	PM130-010005XX
3 phase motor	230/460 V / 5 HP	PM131-010005XX
Progressive start control	220 V 1 HP to 230/460 V 3 HP	PM421-010005XX
Connection kit for progressive start	Miscellaneous parts	EL421-114200XX

PUMP R0165 (OIL 7 L)	58 SCFM @ 15" (MAX.: 29,9 PO/HG)	CODE
Single phase motor	220 V / 7,5 HP	PM130-016507XX
3 phase motor	230/460 V / 7,5 HP	PM131-016507XX
Progressive start control	220 V 1 HP to 230/460 V 3 HP	PM421-016507XX
Connection kit for progressive start	Miscellaneous parts	EL421-125200XX

PUMP R0205 (OIL 7 L)	65 SCFM @ 15" (MAX.: 29,9 PO/HG)	CODE
Single phase motor	220 V / 7,5 HP	PM130-020507XX
3 phase motor	230/460 V / 7,5 HP	PM131-020507XX
Progressive start control	220 V 1 HP to 230/460 V 3 HP	PM421-020507XX
Connection kit for progressive start	Miscellaneous parts	EL421-125200XX

PUMP R0255 (OIL 7 L)	85 SCFM @ 15" (MAX.: 29,9 PO/HG)	CODE
Single phase motor	220 V / 10 HP	PM130-025510XX
3 phase motor	230/460 V / 10 HP	PM131-025510XX
Progressive start control	220 V 1 HP to 230/460 V 3 HP	PM421-025510XX
Connection kit for progressive start	Miscellaneous parts	EL421-132200XX

PUMP R0305 (OIL 7 L)	98 SCFM @ 15" (MAX.: 29,9 PO/HG)	CODE
3 phase motor	230/460 V / 10 HP	PM131-030510XX
Progressive start control	230 V 1 HP to 230/460 V 3 HP	PM421-030510XX
Connection kit for progressive start	Miscellaneous parts	EL421-132200XX

PUMP R0400, 20 HP	153 SCFM @ 15" (MAX.: 29,9 IN/HG) SEE YOUR SALES REPRESENTATIVE FOR DETAILS
-------------------	--

PUMP R0630, 25 HP	228 SCFM @ 15" (MAX.: 29,9 IN/HG) SEE YOUR SALES REPRESENTATIVE FOR DETAILS
-------------------	--

SIHI pump available with progressive start variable speed drive.



SCAN THE QR CODE
 to discover our complete variety



Single stage



Double stage



ELAPIERRE.COM
Online Store



SERVICE LIQUID TANK (FOR LIQUID RING VACUUM PUMP)	CODE
18" x 36" x 34" 66 gal (79 USG) (comes with overflow pipe)	BA001-180334S3



SUPPORT FOR SIHI VACUUM PUMP (WALL MOUNTING)	CODE
Set of 2 (16" x 16")	PM468-321616XX

GUZZLER ELECTRIC SINGLE DIAPHRAGM PUMP	CODE
GE-0401N, 3/4 - 1 1/4", 115 V, up to 400 taps	PM007-040116NX
Service kit (diaphragm & flapper valves)	PM407-000017XX
Diaphragm	PM407-000013XX



GUZZLER ELECTRIC DOUBLE DIAPHRAGM PUMP	CODE
G2-0501N, 1 1/4", 115 V, up to 800 taps	PM008-050116NX
G2-0504N, 1 1/4", 24 V, up to 800 taps	PM009-050424NX
Service kit (diaphragm & flapper valves)	PM408-000017FX
Diaphragm	PM407-000013XX



GUZZLER ELECTRIC QUAD DIAPHRAGM PUMP	CODE
G4-0501N 115 V, jusqu'à 28 HG	PM007-050120XX

CONVERSION SET	CODE
1 Santoprene diaphragm, pump button 1/4", stainless steel washer	PM408-000018XX



A - TESTER	CODE
CFM tester	PM199-000001KT

VACUUM OIL	CODE
68 high performance 18.9 L (5 USG)	DV461-006818XX
100 flood 18,9 L (4,99 USG)	DV461-010018XX

B - MAGNETIC STARTER (240 VOLTS, 1 HP AUTO/OFF/ON)	CODE
3 HP	PM380-000003XX
5 HP	PM380-000005XX
7,5 HP	PM380-000007XX
10 HP	PM380-000010XX

C - VERTICAL HUMIDITY TRAP	CODE
2" ball	TH002-000002NX
3" ball	TH002-000003NX

D - CONTROL TEMPERATURE CONNEXION	CODE
for drive and magnetic starter (120 Volts)	EL521-419001XX

E - VERTICAL ELECTRIC HUMIDITY TRAP	CODE
14" X 25 1/2" with 3" inlet and outlet, 3" flap included	TH003-031425XX

F - BERNARD HUMIDITY TRAP	CODE
Built-in lateral water sight level and drain (electric switch included)	507-D

* It is strongly recommended to add the vacuum breaker valve option.

G - 3/4" VACUUM BREAKER VALVE	CODE
3/4" Vacuum breaker valve	TH060-120001XX
With options (valve, elbow and nipple)	TH060-120001KT

VACUUM REGULATOR	CODE
H - Vacuum regulator 1 1/2" (Fits on 1 1/2" male and 2" female)	PM400-000001XX
I - High flow vacuum regulator	PM400-000002XX

A COMPLETE RANGE OF SS STORAGE TANKS

- Made with first grade materials;
- Structural metal chosen according to tank size to satisfy the most demanding sugarmakers;
- Side reinforcement bars made to strenghten the sides when tank is full to the top (4 feet and bigger);
- All aluminum frames on 3' x 4' and smaller storage tanks;
- Full steel structure on 4' x 6' tanks and up.

DIMENSION WIDTH	DIMENSION LENGTH	OUTLET
2', 3', 4', 5'	up to 8'	1 1/2" mâle NPT
more than 5'	more than 8'	2" mâle NPT
6', 7 1/2'	any length	2" mâle NPT



18" WIDE	IMP G.	USG	LITERS	BRIGHT ANNEALED 304-BA
18" x 4' x 26 1/4"	63	76	288	BA001-180426S3
18" x 4' x 34"	88	105	397	BA001-180434S3

2' WIDE	IMP G.	USG	LITERS	BRIGHT ANNEALED 304-BA
2' x 4' x 29"	98	117	443	BA001-020429S3
2' x 4' x 41"	148	177	670	BA001-020441S3

3' WIDE	IMP G.	USG	LITERS	BRIGHT ANNEALED 304-BA
3' x 4' x 36 3/4"	193	231	874	BA001-030436S3
3' x 4' x 48 3/4"	267	321	1215	BA001-030448S3
3' x 8' x 24"	217	260	984	BA001-030824S3
3' x 8' x 37 1/2"	385	462	1749	BA001-030837S3
3' x 8' x 49 1/2"	535	642	2430	BA001-030849S3
3' x 12' x 37 1/2"	578	693	2623	BA001-031237S3
3' x 12' x 49 1/2"	802	963	3645	BA001-031249S3
3' x 16' x 37 1/2"	770	924	3498	BA001-031637S3
3' x 16' x 49 1/2"	1070	1283	4857	BA001-031649S3

NO SPACER NEEDED TO CONNECT TO DRAIN FITTINGS

Our special design gives you clearance.

MPT STAINLESS STEEL OUTLET OPTION ON TANK

Overflow od drain welded in the tank. See page 64. Option 3" outlet instead of 2" on tank 5', 6' and 7 1/2' wide. Contact your Lapierre representative for more information.

*Important : the tank will be 2" higher if outlet of 3",

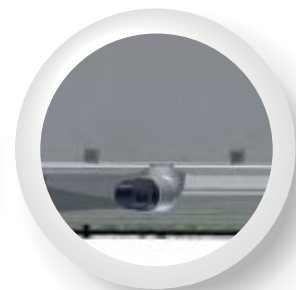
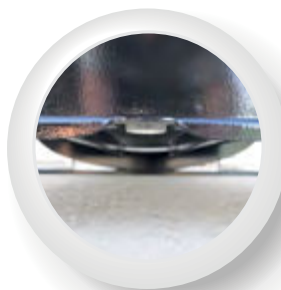

4' WIDE	IMP. G	USG	LITERS	BRIGHT ANNEALED 304-BA
4' x 4' x 33 1/4"	216	259	980	BA001-040433S3
4' x 4' x 45 1/4"	316	379	1435	BA001-040445S3
4' x 8' x 33 1/4"	432	519	1964	BA001-040833S3
4' x 8' x 45 1/4"	632	758	2869	BA001-040845S3
4' x 8' x 52 3/4"	757	908	3437	BA001-040852S3
4' x 12' x 33 1/4"	648	778	2945	BA001-041233S3
4' x 12' x 45 1/4"	948	1137	4304	BA001-041245S3
4' x 12' x 52 3/4"	1135	1362	5156	BA001-041252S3
4' x 12' x 60"	1310	1572	5950	BA001-041260S3
4' x 16' x 33 1/4"	864	1037	3925	BA001-041633S3
4' x 16' x 45 1/4"	1264	1516	5739	BA001-041645S3
4' x 16' x 52 3/4"	1513	1816	6874	BA001-041652S3
4' x 16' x 60"	1746	2095	7930	BA001-041660S3

Pour commander nos tuyaux de trop-plein selon nos grandeurs standards, veuillez suivre cette procédure

Tuyau de trop-plein 1 1/2" (BA404-01**24XX)

Tuyau de trop-plein 2" (BA404-01**32XX)

Tuyau de trop-plein 3" (BA404-00**48XX)

À partir du code générique, remplacez les 2 étoiles par la longueur du tuyau.

Exemple: Tuyau de trop-plein 1 1/2" x 11" de long : BA404-011124XX.

Nos sorties de drain sont machinées avec précision pour que les tuyaux de trop-plein puissent s'y adapter parfaitement.



- Superior quality construction;
- Heavy duty structure;
- Extra structure to minimize support points.



PERSONNALIZED PANEL FOR STAINLESS STEEK TANK	CODE
1 side	BA001-000001XX
2 sides	BA001-000002XX

CUSTOMIZABLE NAME ON THE FRONT PLATE

5' WIDE	IMP. G	USG	LITERS	BRIGHT ANNEALED 304-BA
5' x 8' x 29 1/4"	438	525	1987	BA001-050829S3
5' x 8' x 41 1/4"	687	824	3119	BA001-050841S3
5' x 8' x 50 1/2"	879	1055	3994	BA001-050850S3
5' x 8' x 64 1/4"	1165	1398	5292	BA001-050864S3
5' x 8' x 84"	1576	1891	7158	BA001-050884S3
5' x 12' x 29 1/4"	656	788	2983	BA001-051229S3
5' x 12' x 41 1/4"	1031	1237	4683	BA001-051241S3
5' x 12' x 50 1/2"	1319	1583	5992	BA001-051250S3
5' x 12' x 64 1/4"	1748	2098	7942	BA001-051264S3
5' x 12' x 84"	2364	2837	10739	BA001-051284S3
5' x 16' x 29 1/4"	875	1050	3975	BA001-051629S3
5' x 16' x 41 1/4"	1374	1649	6242	BA001-051641S3
5' x 16' x 50 1/2"	1759	2111	7991	BA001-051650S3
5' x 16' x 64 1/4"	2331	2797	10588	BA001-051664S3
5' x 16' x 84"	3152	3783	14320	BA001-051684S3
5' x 20' x 29 1/4"	1094	1313	4970	BA001-052029S3
5' x 20' x 41 1/4"	1718	2061	7802	BA001-052041S3
5' x 20' x 50 1/2"	2198	2638	9986	BA001-052050S3
5' x 20' x 64 1/4"	2913	3496	13234	BA001-052064S3
5' x 20' x 84"	3940	4728	17897	BA001-052084S3
5' x 24' x 41 1/4"	2061	2473	9361	BA001-052441S3
5' x 24' x 64 1/4"	3495	4195	15880	BA001-052464S3
5' x 24' x 84"	4728	5674	21478	BA001-052484S3

6' WIDE	IMP. G	USG	LITERS	BRIGHT ANNEALED 304-BA
6' x 8' x 49 1/2"	1009	1211	4584	BA001-060849S3
6' x 8' x 61 1/2"	1309	1570	5943	BA001-060861S3
6' x 8' x 73 1/2"	1608	1930	7306	BA001-060873S3
6' x 12' x 49 1/2"	1514	1816	6874	BA001-061249S3
6' x 12' x 61 1/2"	1963	2355	8915	BA001-061261S3
6' x 12' x 73 1/2"	2412	2894	11296	BA001-061273S3
6' x 12' x 84"	2812	3375	12776	BA001-061284S3
6' x 16' x 49 1/2"	2018	2422	9168	BA001-061649S3
6' x 16' x 61 1/2"	2617	3141	11890	BA001-061661S3
6' x 16' x 73 1/2"	3216	3859	14608	BA001-061673S3
6' x 16' x 84"	3750	4499	17031	BA001-061684S3
6' x 20' x 49 1/2"	2523	3027	11458	BA001-062049S3
6' x 20' x 61 1/2"	3271	3926	14862	BA001-062061S3
6' x 20' x 73 1/2"	4020	4824	18261	BA001-062073S3
6' x 20' x 84"	4687	5624	21289	BA001-062084S3
6' x 24' x 49 1/2"	3027	3633	13753	BA001-062449S3
6' x 24' x 61 1/2"	3926	4711	17833	BA001-062461S3
6' x 24' x 73 1/2"	4824	5789	21914	BA001-062473S3
6' x 24' x 84"	5624	6749	25548	BA001-062484S3

7 1/2' WIDE	IMP. G	USG	LITERS	BRIGHT ANNEALED 304-BA
7 1/2' x 8' x 84"	2322	2786	10546	BA001-070884S3
7 1/2' x 12' x 66"	2641	3169	11996	BA001-071266S3
7 1/2' x 12' x 84"	3483	4179	15819	BA001-071284S3
7 1/2' x 16' x 66"	3521	4225	15993	BA001-071666S3
7 1/2' x 16' x 84"	4644	5573	21096	BA001-071684S3
7 1/2' x 20' x 66"	4401	5281	19991	BA001-072066S3
7 1/2' x 20' x 84"	5805	6966	26369	BA001-072084S3
7 1/2' x 24' x 66"	5281	6338	23992	BA001-072466S3
7 1/2' x 24' x 84"	6966	8359	31642	BA001-072484S3

STAINLESS STEEL SAP SILO

DIMENSION	GAL IMP.	GAL US	CODE
8' x 8'	2500	3000	BA002-008008SS
8' x 10'	3000	3600	BA002-008010SS
8' x 12'	3750	4500	BA002-008012SS
8' x 15'	4700	5640	BA002-008015SS
8' x 25'	7200	8366	BA002-008025SS
10' x 12'	5500	6600	BA002-010012SS
10' x 15'	6625	7950	BA002-010015SS
10' x 20'	9000	10800	BA002-010020SS
10' x 25'	11620	14000	BA002-010025SS
12' x 15'	10000	12000	BA002-012015SS
12' x 20'	13850	16620	BA002-012020SS
12' x 25'	17500	21000	BA002-012025SS
12' x 30'	19000	22818	BA002-012030SS

INCLUDED ACCESSORIES

- Access door on top
- Bottom access door
- Exterior ladder
- One air vent with screen
- One rotary washing ball
- One inlet and one overflow on 2" (5.08 cm) ferrule (standard) or 2" MPT threaded (on demand)
- One outlet on 3" (7.62 cm) ferrule (standard) or 3" MPT threaded (on demand)
- Standardized ladders, walkway and guardrails



OPTIONS FOR STAINLESS STEEL SAP SILO	CODE
Logo	BA102-000000XX
Protection cage for 15' sap silo external ladder	BA102-040015XX
Protection cage for 20' sap silo external ladder	BA102-040020XX
Protection cage for 25' sap silo external ladder	BA102-040025XX
Overflow 3" only instead of 2" standard	BA102-060048XX
Overflow 4" only instead of 2" standard	BA102-060064XX
Top feed plumbing, option 2" including attachment plate	BA102-050032XX
Top feed plumbing, option 3" including attachment plate	BA102-050048XX
Top feed plumbing, option 4" including attachment plate	BA102-050064XX
Overflow outlet plumbing down, option 4"	BA102-070064XX
Stainless steel wash ball feed plumbing	BA102-090000XX
Inlet or additional bottom outlet 1 1/2", 2", 3" or 4"	BA102-080000XX
Inlet or additional bottom outlet 1 1/2", 2", 3" or 4" MPT	BA102-080000MX
Building stainless steel connection box	BA102-100000XX
Attachment plate for piping kit	BA102-110000XX

HORIZONTAL SAP SILO IN STAINLESS STEEL

DIMENSION	GAL IMP.	GAL US	CODE
12' x 25'	17500	21000	BA022-012025SS

STAINLESS STEEL TRANSPORT TANK

DIMENSION	GAL IMP.	GAL US	CODE
46" x 5'	358	430	BA008-046005SS
46" x 6'	431	518	BA008-046006SS
54" x 8'	791	950	BA008-054008SS
54" x 10'	999	1200	BA008-054010SS
54" x 12'	1187	1425	BA008-054012SS
76" x 10'	1957	2350	BA008-076010SS
76" x 12'	2352	2825	BA008-076012SS
76" x 15'	2939	3530	BA008-076015SS
76" x 20'	3914	4700	BA008-076020SS
8' x 25'	7190	8628	BA008-008025SS (STATIONARY)

STAINLESS STEEL TRANSPORT TANK WITHOUT ANTI-WAVE

DIMENSION	GAL IMP.	GAL US	CODE
46" x 5'	358	430	BA018-046005SS
46" x 6'	431	518	BA018-046006SS

OPTIONS TRANSPORT TANK	CODE
Logo	BA102-000000XX



INCLUDED ACCESSORIES

- Two stainless steel supports with holes for bolting
- One bottom elbow outlet with 2" MPT (standard) ou 2" ferrule (special order)
- One access door on top 20" x 20"
- Washing ball
- Two hooks on the top and four clips on the side
- Anti-wave (except on the 46" diameter)
- One interior step
- Stainless steel exterior steps

INCLUDED ACCESSORIES	46"	54"	76"
2 stainless steel supports with holes for bolting	✓	✓	✓
1 bottom elbow outlet with 2" MPT (std) or 2" ferrule (on demand)	✓	✓	✓
1 access door on top 20" x 20"	✓	✓	✓
2 hooks on the top and 4 clips on the side	✓	✓	✓
Washing ball	1	2	2
Anti-wave	-	1	1
1 interior step	✓	✓	✓
Stainless steel exterior steps	✓	✓	✓



WITH ITS EXPANDABLE DESIGN, OUR UPDATED RANGE OF R.O.'S WILL CONTINUALLY GIVE YOU MORE!

UPGRADE TO A HIGHER STANDARD IN NO TIME

Nowadays, R.O.'s are essential pieces of equipment for maple syrup producers in a world-class economy. By removing more than 50% to 95% of the water contained in the sap, the use of an R.O. results in substantial savings in the fuel used for evaporation.

The scalable construction of Lapierre R.O.'s mounted on a stainless steel frame allows components such as pumps and housings to be upgraded to optimize the performance of your equipment to achieve the desired throughput.

Lapierre's high efficiency recirculation design allows your R.O. to operate at a high Brix level throughout the day, without washing or rinsing the membranes (under recommended conditions).

By optimizing the capacity of our high-pressure pumps and choosing the right motors, we are proud to offer you the most energy-efficient range of high-performance R.O.'s on the market.

No other brand of R.O. has such a high resale value on the market.

UNMATCHED RELIABILITY AND SIMPLICITY

- Choice of 5 HP high pressure pumps of 10 or 20 GPM according to your needs
- Increased performance through an easy addition of membranes, high pressure pump, booster pump, etc.
- Wheeled system for effortless movement

INCLUDED WITH PURCHASE

- Stainless steel wash tank
- Membrane and storage canister
- 20" pre-filter and pre-filter protector
- Lubricant for sealing joints
- Connection pipe
- Membrane cap and adaptor
- Membrane soap

THE R.O. SPECIALIST

We are experts at customizing your R.O. to your specific needs.

Our proven expertise in maple syrup production enables us to optimize the performance of equipment from other manufacturers.

THE LOWEST ENERGY CONSUMPTION ON THE MARKET STANDARD: 230 V / 1 PHASE

AVAILABLE: 600 V / 3 PHASE / 208 / 230 3 PHASE

FOR EXAMPLE:

**3000 SERIES 5 HP
2 MEMBRANES: 42 AMPS**

**5000 SERIES
12 MEMBRANES: 131 AMPS**



10000 SERIES



OUR INDUSTRIAL GRADE R.O.

TOUGHER FOR BETTER PERFORMANCE!

Lapierre is proud to present the very first industrial grade R.O. developed with ingenuity and optimized for large-scale maple syrup operations. Unparalleled in durability and operating flexibility, the 10K Series, mounted on a solid frame and made entirely of stainless steel, has been designed to meet the most demanding maple syrup producers' performance requirements.

Powerful and compact, the horizontal configuration of the 10000 Series, as well as its all-stainless steel filter unit installed above the wash tank, greatly improves maintenance operations. For maximum efficiency, the 10000 Series allows up to 15 double membrane systems, for a total of 30 membranes. That's serious performance!

CONFIGURATIONS

- Up to 30 membranes in 15 double housings with 1.5 HP recirculation
- 1 feed pump with variable speed drive
- 2 high-pressure pumps with variable speed drive
- 1 to 3 booster pump(s) with variable speed drive
- Stainless steel sap filters with 6 cartridges for concentration
- Stainless steel sap filters with 6 cartridges for washing

AVAILABLE OPTIONS

- Stainless steel 10 gal flowmeter bracket
- Element, thermostat and water level control on wash tank
- Automation system

5000 SERIES

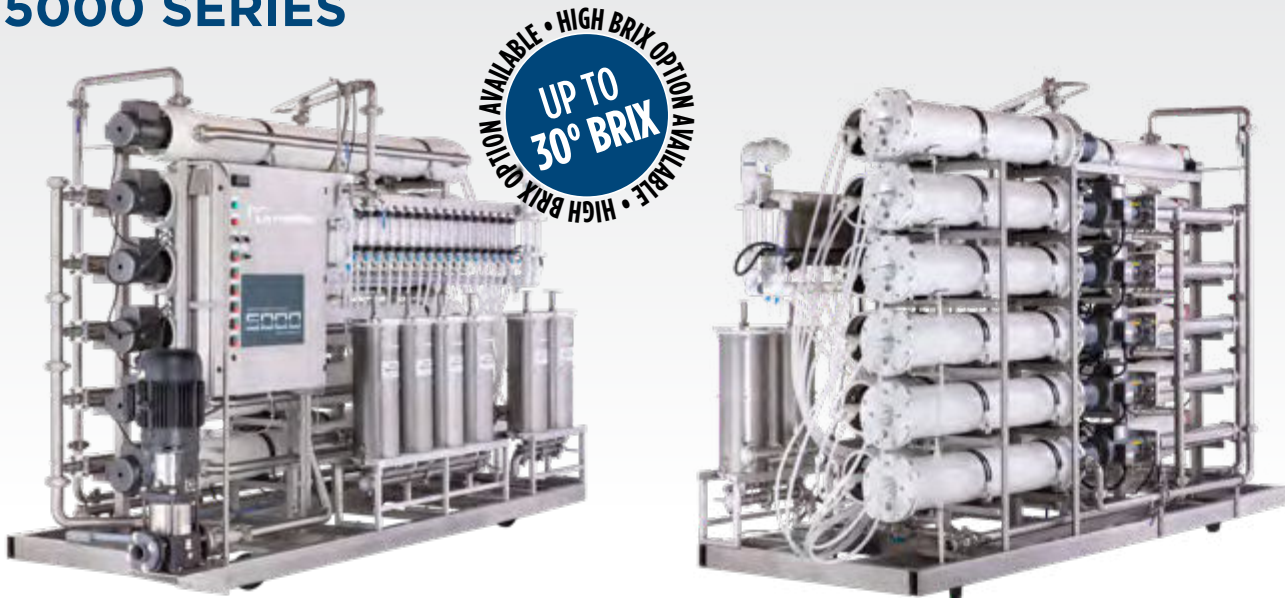

AN R.O. THAT KEEPS ITS PROMISES

The 5000 Series has proven itself to be the industry's highest performing equipment. A single pass for a concentration of 20 Brix or more makes it the system with the lowest power consumption rate in the industry. The 5000 Series is also built on a stainless steel frame and has a scalable design that can accommodate up to 12 membrane systems (6 single and 6 double for a total of 18 membranes) as well as all the pumps in a complementary configuration. High performance for days on end!

STANDARD CONFIGURATIONS (UP TO 20° BRIX / 25° BRIX WITH A BOOSTER PUMP)

	15 HP / 9 MEMBRANES	15 HP / 12 MEMBRANES	20 HP / 15 MEMBRANES	25 HP / 18 MEMBRANES
Feed pump	Goulds 5 HP 2St	Goulds 5 HP 2St	Goulds 5 HP 2St	7.5 HP + variable
High pressure pump	3 x 5 HP 20 GPM	3 x 5 HP 20 GPM	4 x 5 HP 20 GPM	5 x 5 HP 20 GPM
Simple vessel 3/4 HP	3	4	5	6
Double vessel 1 1/2 HP	3	4	5	6
Wash tank	3' x 3'	3' x 3'	3' x 4'	3' x 4'
Stainless steel water filter with 6 cartridges for concentration	2	3	4	4
Stainless steel water filter with 6 cartridges for washing	1	1	1	1

AVAILABLE OPTIONS

- Stainless steel rack for flowmeter 10GPM (9, 12, 15 or 18 kit)
- Element, thermostat and water level control on wash tank
- Automation system
- 1 or 2 booster pump(s)
- Wash pump

NEW

PRO SERIES

PERFORMANCE ON A LARGE SCALE

The **PRO SERIES** is the culmination of our extensive expertise in maple syrup production equipment engineering and full-scale field experimentation. The inquisitive and innovative nature of our R&D lab staff also plays a key role here. *Clearly, the result is one of great astonishment.* The majority of small and medium-sized maple syrup producers are won over by both the power and the effective Brix concentration of the PRO SERIES. In short, its practical and technical performance is definitely comparable to that of higher-capacity maple syrup equipment. **THE PRO SERIES IS PATENT PENDING.**



The PRO SERIES can only be described by these powerful words: **PERFORMANCE ON A LARGE SCALE..** Designed for sugar bushes with 2,000 to 20,000 taps, here's why the modest **LAPIERRE PRO SERIES** performs like the big boys:

- Ingenious design for superior performance
- Starting pressure over 700 psi with a single pressure level
- Sustained concentration up to 30 Brix degrees or more in a single operation
 - The AUTOBRIX valve controller ensures constant Brix degrees.
- Continuous output from 800 to 1,600 gph
- Choice of manual, remote, or automated control

Possible configurations:

- 1 or 2 high-pressure 7.5 HP pumps with frequency converter
 - Maximum optimization of energy-efficient yields and membranes
 - 1 pump, 2 membranes: 50 amps on 120/240 volts, 1 phase
 - 2 pumps, 4 membranes: 90 amps on 120/240 volts, 1 phase
 - 2 to 4 membranes
- Flexible modular space configuration for the 2000 to 3000 Elite series



UP TO 30° BRIX
HIGH BRIX OPTION AVAILABLE

3000 SERIES

A little gem for producers with more than 3000 taps who are looking for performance and a concentration of 18 Brix or more. This is an R.O. mounted on a stainless steel frame with 5 hp-20 gal high pressure pumps and a scalable configuration allowing operation of up to 8 stainless steel housings. Raw power!

STANDARD CONFIGURATIONS (UP TO 20° BRIX)

MODEL TURBO	TURBO HP PUMP	FEED PUMP	SIMPLE VESSEL 8"	DOUBLE VESSEL 8"
TURBO 5 HP	1 x 5 HP (20 GPM)	2 HP Goulds	2	0
TURBO 10 HP	2 x 5 HP (20 GPM)	5 HP Goulds	4	0
TURBO 15 HP	3 x 5 HP (20 GPM)	5 HP Goulds	6	0

MODULAR CONFIGURATION WITH BOOSTER PUMP (UP TO 25° BRIX)

MODEL TURBO	TURBO HP PUMP	FEED PUMP	SIMPLE VESSEL 8"	DOUBLE VESSEL 8"
TURBO 10 HP	2 x 5 HP (20 GPM)	5 HP Goulds	2	2
TURBO 15 HP	3 x 5 HP (20 GPM)	5 HP Goulds	3	3

Options for the 3000 and 3000 ELITE Series

- Two 5 way quick connect valves for concentrate and filtrate
- Concentrate and filtrate valve panel (3000 only)
- Optional stainless steel feed pump cover and high pressure pump cover (3000 only)
- Continuous Brix reader or AUTOBRIX valve including continuous Brix reader
- Various sizes of rectangular stainless steel wash tank with filtration installed on the tank (3000 only)
- Element and thermostat on wash tank
- Magnetic box and water level control on wash tank
- Up to 8 recirculations
- Horizontal support for SS housings
- SS housing in polished stainless steel
- Filtrate sampler for ss housing
- Booster pump
- Flowmeter panel for filtrate with samplers
- Filtrate flowmeter 20 additional gallons
- Addition of pre-filters for concentration and washing
- Sap filter with fabric or 6 cartridges
- 35 gallon flowmeter

Many possible configurations when purchasing an R.O. with a 5 HP turbo pump.

3000 ELITE SERIES

A new star is born. This newcomer to the Lapierre R.O. family stands out for its ingenious design and all stainless steel construction. The integrated wash tank allows for minimal plumbing, ease of operation and an unmatched look. High pressure pumps are controlled by VFD for a better control of the pressure and to optimize energy efficiency of the R.O.

Available with automated option,
3K ELITE



Photo : 3K ELITE with modular membrane vessel rack

CONFIGURATION STANDARD (UP TO 20° BRIX)

MODEL ELITE	TURBO HP PUMP	FEED PUMP	SIMPLE VESSEL 8"	DOUBLE VESSEL 8"
ELITE 5 HP	1 x 5 HP (20 GPM)	2 HP Goulds	2	0
ELITE 10 HP	2 x 5 HP (20 GPM)	5 HP Goulds	4	0
ELITE 15 HP	3 x 5 HP (20 GPM)	5 HP Goulds	6	0

MODULAR CONFIGURATION WITH BOOSTER PUMP (UP TO 25° BRIX)

MODEL ELITE	TURBO HP PUMP	FEED PUMP	SIMPLE VESSEL 8"	DOUBLE VESSEL 8"
ELITE 10 HP	2 x 5 HP (20 GPM)	5 HP Goulds	2	2
ELITE 15 HP	3 x 5 HP (20 GPM)	5 HP Goulds	3	3

HYPERBRIX™ R.O. (UP TO 35° BRIX)



HYPERBRIX® R.O. Technology will save you time and energy. 2 Brix sap to 35 Brix concentrate in one single pass!

You have not seen everything yet in R.O. sap concentration technology! Lapierre's HYPERBRIX®, process can reduce the volume of water to be evaporated by 95%.

- Each HYPERBRIX® R.O. is paired with a HYPERBRIX® evaporator especially adapted for the task of cooking syrup from 35 Brix concentrate, with an emphasis on flavour development;
- The process developed by Lapierre retains all the elements present in the sap, resulting in uncompromising maple syrup;
- HYPERBRIX® technology is the solution for achieving the lowest maple syrup production cost.



3k, 5k and 10k automated systems

Lapierre R.O.'s have been continually evolving for more than 30 years. With the most complete product family in the industry, we can meet the needs of the smallest producers all the way up to industrial maple syrup operations.

We are proud to introduce our brand new Lapierre R.O. automation system, designed to improve and simplify maple syrup production. You can control it remotely from anywhere on the planet! This provides optimal performance and simplifies its operation while providing live production data via the dashboard.

If necessary, this equipment can be operated in both automatic and manual modes.

- Access to the machine at all times via the Internet
- Concentrate and filtrate flows, continuous Brix level, operating pressures, maple filtrate and concentrate water reservoir levels, operating mode
- Automatic start according to the level of the sap tank level.
- Remote control of operations: concentration, washing, rinsing, desugaring, Pep, Brix levels, start/stop, etc.
- Alarms classified by importance and transmitted by email in real time
- 12-inch easy to use and user-friendly touch screen
- Automatic purging to facilitate feed pump start-up
- Automatic washing
- Automatic quick action valves
- Integrated WiFi and VPN routers
- Unique feature that toggles from automatic to manual mode at the touch of a button, allowing instrument operation and reading (pressures, flow rates and temperature) without using the controller.
- Multi-tank management option (allows management of filling and concentration up to 6 tanks of sap, concentrate or filtrate)

	AUTOMATED SYSTEM	MANUAL				AUTOMATED	
		SERIES	OPTION	REMOTE CONTROL	OPTION	SERIES	OPTION
VALVE MANAGEMENT	Control maple sap tank inlet			✓		✓	
	Control maple sap tank inlet (up to 6 tanks)						✓
	Control filtrate tank inlet			✓		✓	
	Control filtrate tank inlet (up to 6 tanks)						✓
	Control wash tank inlet		✓	✓		✓	
	Control Wash tank drain	✓		✓		✓	
	Control concentration valve	✓			✓		✓
	Control pressure valve	✓					
	Control all pressure levels					✓	
	Control concentrate outlet valve		✓	✓		✓	
	Control concentrate outlet valves (up to 6 tanks)						✓
	Control concentrate filtrate valve		✓	✓		✓	
	Control concentrate filtrate valves (up to 6 tanks)						✓
	Control outlet valve to wash tank		✓	✓		✓	
	Control outlet valve to wash filter				✓	✓	
	Control wash tank fill			✓		✓	
	Valve management for the second filtration bank						✓
	Control maple water tank filling valves (up to 6 tanks)						✓
ACCESSORIES	Inlet and/or outlet Brix reading		✓		✓		✓
	Digital reading of concentrate flow rate					✓	
	Digital reading of filtrate flow rate					✓	
	Reading concentrate detection at tank inlet						✓
	Display maple sap tank level			✓		✓	
	Display filtrate tank level					✓	
	Display concentrate tank level			✓		✓	
	Reading conductivity						✓
	Soap pump						✓
	Selector switch manual mode					✓	
	Digital reading all pressure levels					✓	
PROCESS/ACTIONS	Brix control		✓		✓		✓
	Rinse after washing			✓		✓	
	Customized wash settings					✓	
	Desugaring after concentration			✓		✓	
	Repeating hot water loop					✓	
	Preventive management of membrane clogging					✓	
	Lower flow rate end of concentration with turbine management					✓	
	Washing management in accordance with PEP and biological standards					✓	
	Concentration start according maple sap tank level					✓	
	Maple sap tank filling management						✓
	Sending alarm or event messages					✓	
	Concentration start progressive flow					✓	
	Management 2 filtration banks						✓



2000 SERIES

The 2000 Series is the R.O. of choice for producers operating a sugar bush with more than 1000 taps. Built with a stainless steel frame, it can be mounted with a high pressure pump of 3 HP-5 GPM or 5 HP-10 GPM. It is also pre-wired to connect two membranes.

2000 Series

STANDARD CONFIGURATIONS (UP TO 20° BRIX)

MODEL	TURBO HP PUMP	FEED PUMP	MEMBRANE + SS BOX 4"	MEMBRANE + SS BOX 8"	TANK	PREFILTER
TURBO 3 HP	1 x 3 HP (5 GPM)	1/2 HP Goulds	1	-	R32	1
TURBO 3 HP	1 x 3 HP (5 GPM)	1/2 HP Goulds	2	-	R32	1
TURBO 5 HP	1 x 5 HP (10 GPM)	1 HP Goulds	-	1	R32	1
TURBO 5 HP	1 x 5 HP (10 GPM)	1 HP Goulds	-	2	R32	2

Options for 2000 Series 3 HP and 5 HP

- 2 5-way quick-connect valves for concentrate and filtrate
- Concentrate and filtrate valve panel
- Optional stainless steel feed pump cover and high pressure pump cover
- Continuous Brix reader
- AUTOBRIX valve including continuous Brix reader
- Rectangular 29 gal stainless steel wash tank with filtration installed on the tank
- Element, thermostat and water level control on wash tank

Options for 2000 Series 5 HP only

- SS Polished Stainless Steel Housing (only for 8" housing)
- Filtrate sampler for SS housing
- Flowmeter panel for filtrate with samplers
- Addition of pre-filters for concentration and washing
- Sap filter with fabric or 6 cartridges

Many possible configurations when purchasing an R.O. with a 5 HP turbo pump.



1000 SERIES

Designed for traditional production and smaller operations, our 1000 series R.O.'s with 1 or 2 vessels offers guaranteed joy for maple syrup producers. If the R.O. reduces the boiling time and the amount of wood used to produce maple syrup, the 1000 series captivates with its remarkable ease of operation.

This range is PURE CONCENTRATED JOY for all its users.

1000 SERIES

MODEL	TURBO HP PUMP	FEED PUMP	MEMBRANE + SS BOX 4"	TANK	PREFILTER	VALVE PANEL
100	1 x 2 HP	3/4 HP	1	Integrated	1	Optional
200	1 x 2 HP	3/4 HP	2	Integrated	1	Optional

Performance

1 Vessel 250 to 750 Taps

2 Vessels 750 to 1,000 Taps

Concentration Up to 8 Brix in optimal conditions

Options

- Stainless steel wash tank
- Expansion kit (2nd vessel)
- Preventive maintenance kit

Electrical components

- 3/4 HP feed pump
- Integrated 2 HP high pressure and recirculation pump
- Voltage: 240 volts; current: 16 amps

Stainless steel components

- Integrated frame and handles
- 4 in. (10.16 cm) vessel
- Pump vessels
- Piping

R.O.'S REMOTE CONTROL SYSTEM

Offered as an option on our concentrators, this system is a simplified version of the automation already offered on our reverse osmosis systems. It simplifies operations and allows remote control of your R.O. via the touch screen of the main computer located near the reverse osmosis machine, via a remote computer or via a mobile device.

This system is offered at a very competitive price, and easily integrates with all our previous concentrator models, as well as most of the competition R.O.'s.

System Details

- 4 cycle operations: concentration, desugaring, washing and rinsing.
- Cycle settings: duration, choice of high-pressure pumps used and Brix level (with the integrated Autobrix option).
- Feedback: current cycle stage, filter outlet pressure, Brix level (with the integrated Autobrix option).
- Web interface for remote connection to perform several operations on the concentrator from a remote computer or mobile device.
- Emergency breaker to enter manual mode in the event of control problems.
- Sensor and valve testing adjustments via the main computer touch screen.
- Touch screen on the main computer to operate multiple operations on the R.O.



NEW

GLASS BEAD FILTRATION SYSTEM



The Lapierre glass bead filtration system offers a ultimate filtration experience to ensure the cleanliness of your maple sap. By using the recommended filtration media, our system can filter down to 3 microns, which is a superior filtration compared to standard concentrator filtration cartridges (5 microns). This means you can save greatly on disposable cartridges without compromising the quality of your sap.

The Lapierre filtration system is easy to maintain with its backwash cleaning process. Furthermore, with its minimal maintenance, you can be sure that your system will function optimally for many years. Our system stands out with its food-grade stainless steel feed, control valves and tank. Additionally, the drain is equipped with a strainer for effective drainage without losing the beads.

It is important to note that this system does not replace cartridges on the RO, which are the final protection for the membranes in case of filtration issues at the bead filter level.

SAP FILTER	CODE
SS sap filter with glass beads 500 (30 gpm), glass beads not included (65 kg)	FE005-500001SS
SS sap filter with glass beads 700 (60 gpm), glass beads not included (170 kg)	FE005-700001SS
SS sap filter with glass beads 1000 (120 gpm), glass beads not included (570 kg)	FE005-100001SS

24" LAPIERRE SAP FILTER WITH 6 PRE-FILTERS 40 gal capacity (pre-filtered water) 20 gal capacity (non-pre-filtered water) / max. 75 PSI	CODE
Complete sap filter 1" inlet	FE002-240616XX
Complete sap filter 1 1/4" inlet	FE002-240620XX
Complete sap filter 1 1/2" inlet	FE002-240624XX

Uses the same pre-filters as the blue housing.

Lapierre sap filter also available with stainless housing



24" LAPIERRE CLOTH SAP FILTER 15 GAL / MAX. CAPACITY 75 PSI	CODE
Complete sap filter 1" inlet, 2 filter cloths included.	FE001-000016XX
Complete sap filter 1 1/4" inlet	FE001-000020XX
Complete sap filter 1 1/2" inlet	FE001-000024XX
5 micron filter cloth (1)	DV400-002401XX
1 micron filter cloth (1)	DV400-012401XX

FILTRANT MEDIA	CODE
AFM grade 1 25 kg (55 lbs)	FE205-250001XX
AFM grade 2 25 kg (55 lbs)	FE205-250002XX

Consultez votre représentant Lapierre pour plus d'informations.



MODULAR MEMBRANE VESSEL RACK

This flexible design allows multiple configuration. It can accommodate single or double membrane vessels, multy filtration units, booster pumps and even flowmeters for each membrane. The combination of single and double membranes housing, combined to a booster pump allows a higher concentration while maintaining exceptional performance.

5000 series technology is now available on smaller Lapierre R.O.'s



2500 OR 3500 OPTION

More compact with Horizontal membrane vessels

More compact and requiring less space, our 2500/3500 version is available with the 2000 and 3000 Series R.O.'s. The horizontal configuration of the stainless steel vessels on the rack allows quick and easy handling of the membranes at the beginning and end of the season.

*Not available on the 3 HP model



STAINLESS STEEL WASH TANK	CODE
12" x 24" x 36", 29 USG	CN006-122436S3
Sap filter rack (24" tank)	CN427-000002A1
Blue housing rack (24" tank)	CN426-000002A1
12" x 30" x 36", 36 USG	CN006-123036S3
Sap filter rack (30" tank)	CN427-000003A1
Blue housing rack (30" tank)	CN426-000003A1
12" x 36" x 36", 43 USG	CN006-123636S3
Sap filter rack (36" tank)	CN427-000004A1
Blue housing rack (36" tank)	CN426-000004A1
24" x 36" x 36", 84 USG	CN006-243636S3
Sap filter rack (36" tank)	CN427-000004A1
Blue housing rack 70 gal (36" tank)	CN426-000005A1
24" x 48" x 36", 108 USG	CN006-244836S3
18" x 48" x 36", 84 USG	CN006-184836S3
Sap filter rack (48" tank)	CN427-000006A1
Blue housing rack (48" tank)	CN426-000006A1

WASH TANK OPTIONS	CODE
3000 W element	CN415-003000S4
3000 W element and thermostat with stainless steel well	CN005-000001XX
Safety system for heating element (magnetic box and water level control)	CN005-000002S4
Blue box for washing	CN005-000003S4
SS well for temperature control	EL830-010001SS

Various capacities are available depending on the quantity of housings: from 2 HP 20 GPM to 10 HP 100 GPM. Sold with variable speed control for optimal pressure adjustment. Please contact your Lapierre representative for more information.

R.O. BOOSTER PUMP

The booster pump will significantly increase your R.O.'s performance. This pump is installed on the R.O. circuit and is intended to increase operating pressure, total flow rate and Brix level. It is recommended for use on R.O.'s with 3 or more housings. Ask your representative to choose the right model for your machine.

PRESSURE GAUGES GLYCERINE 2,5"	CODE
0-100 lb SS, connexion 1/4"	DV206-010040S6L
0-100 lb Brass lead free, 1/4"	DV206-010040SPL
0-400 lb connexion, SS 1/4"	DV206-040040S6L
0-600 lb SS, connexion 1/4"	DV206-060040S6L
0-600 lb Brass lead free, 1/4"	DV206-060040SPL
0-30 lbs Brass lead free, 1/4"	DV206-003040SPL
0-1000 lbs Brass lead free, 1/4"	DV206-100040SPL



PRESSURE GAUGES DRY 4"	CODE
0-1000 lb SS, connexion 1/4"	DV264-100072S6L
0-1000 lb Brass lead free, 1/4"	DV206-100040S6L

REVERSE OSMOSIS MEMBRANE

4 INCH MEMBRANE	CODE
ESPA4-4040, 4" X 40"	CN034-000440XX

8 INCH MEMBRANE (MAX. 800PSI)	CODE
HYDRAPRO 102, 8" X 40"	CN033-000840XX
HB2535, 8" X 40"	CN027-000840XX

8 INCH MEMBRANE (MAX. 600PSI)	CODE
ESPA4, 8" X 40"	CN034-000840XX



FILTRATE SAMPLER	CODE
3/4" MPT x 3/4" MPT for Lapierre housing	CN410-000001XX
1/2" FPT x 1/2" MPT for Seprotech housing	CN410-000002XX

Several models can accommodate the housings of other brands.

STORAGE TANK	CODE
4" x 40"	CN002-000440XX
8" x 40"	CN002-000840XX



MEMBRANE CLEANING SERVICE

For more than 35 years, Lapierre Equipment has specialized in post-sugar season servicing of your membranes.

Our cleaning service is available to all customers using membranes, regardless of the make and model of their R.O. We pick up and deliver your membrane.

All products used for washing and storage are approved for use by organic sugar bushes. Since we are always looking to improve our customer service, tests are performed on all membranes sent to us for cleaning:

- A sugar test before cleaning
- A performance test before and after cleaning

These tests are provided completely free of charge when you send your membrane for cleaning. In addition, we are available for membrane repairs:

- Damaged fibreglass
- Broken or loose plastic washer

MEMBRANE CLEANING SERVICE	CODE
4" or 8" performance and sugar test	CN401-000000XX
4" performance and sugar test + cleaning	CN401-000401XX
8" performance and sugar test + cleaning	CN401-000801XX

AUTOBRIX VALVE CONTROLLER

The AUTOBRIX valve controller ensures that you get a constant value from the Brix level to your R.O.'s output. Combined with a precise Brix reader, the controller will modulate the opening of the concentrate valve using a highly efficient algorithm.

The constant level of the Brix being targeted optimizes the performance of the evaporator and reduces its consumption and evaporation time. No need for an operator to stand in front of the R.O. constantly to monitor and adjust the opening of the concentrate valve.



- Can be installed on all Lapierre R.O. models as well as all other manufacturers' models;
- Stable and accurate Brix level at the R.O. outlet;
- The AUTOBRIX valve controller can accept data from most Brix drives continuously.

AUTOBRIX VALVE WITHOUT MOUNTING ON CABINET	CODE
AutoBrix valve 3/8" compression low flow	CN175-000406CX
AutoBrix valve 3/8" compression high flow	CN175-000606CX

MOUNTING FOR AUTOBRIX VALVE LOW OR HIGH FLOW	CODE
On cabinet on R.O. 2000, 3000 & 3500	CN375-300006KT
On cabinet on R.O. 5000	CN375-500006KT

BRIX READER	CODE
A - Continuous Brix reader 0-45 Lapierre	CN075-000045XX
B - Continuous Brix reader 0-80	DV176-000080XX

BRIX READER	CODE
Continuous Brix reader Lapierre 0-45 mounted on standard 2000, 3000 & 3500 R.O.	CN375-300045KT
Continuous Brix reader Lapierre 0-45 mounted on standard 5000 & 10000 R.O.	CN375-500045KT
Continuous Brix reader Lapierre 0-45 mounted on standard 5000 R.O. for models 2022 and less	CN375-500045KTA
Brix reader 0-80 mounted on R.O. 3000	DV375-300080KT
Brix reader 0-80 mouted on R.O. 5000	DV375-500080KT

REMOTE CONTROL OPTION ON R.O.	CODE
AutoBrix valve & Brix reader not included	CN371-000001XX

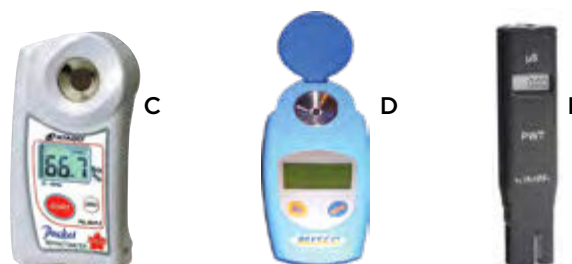
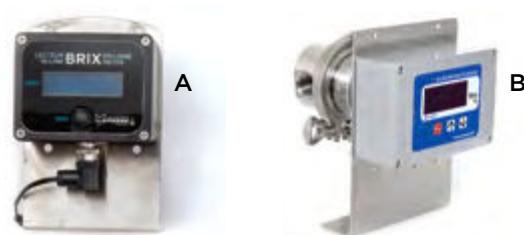

DIGITAL REFRACTOMETER	CODE
C - Atago digital 0-85 Brix	DV013-000085XX
B - Misco digital 0-85 Brix	DV022-000085XX

REFRACTOMETER	CODE
LED backlit 0-32 Brix (sap and high concentrate)	DV014-000032XX
LED backlit 45-82 Brix (syrup)	DV014-004582XX

E - CONDUCTIVIMETER	CODE
Conductivimeter Hanna HI98308 (5 programmable scale)	DV021-098308XX



OFFERED FROM

- 2 1/2' x 8' à 6' x 18'

Super heavy duty arch frame structure.

**F5
TURBO**



THE WOOD COMBUSTION REFERENCE IS GETTING BETTER ALL THE TIME

- The Force 5 has a unique heat exchanger system;
- No smoke, soot or creosote;
- No sparks or embers out of the stack;
- Wood is the least expensive combustible available;
- Excellent insulation (no heat loss on the sides);
- Heat is spreaded uniformly to eliminate hot spots;
- No hot spots means less niter build up;
- Complete control of evaporation intensity.
- Optiflam option available

The time between recharges is particularly long on a FORCE 5 controlled combustion furnace. (it varies depending on the reality of each operator).

The Force 5 TURBO is the fusion between the best combustion controlled FIRED wood arch and the Lapierre-Waterloo-Small designed fire tube double pass Turbo pan. A combination that makes evaporating with wood FUEL even more efficient and economica!



SUPER HEAVY DUTY CONSTRUCTION

Syrup pan	Ends	20 ga
	Sides	22 ga
Flue pan	Walls	18 ga
	Flues	22 ga
Hood	Ends	20 ga
	Sides	22 ga

Super heavy duty arch frame structure.

Force 5 users are pleased with how the heat distribution and its intensity under the pans enhances maple flavor.

Force 5 reaches very high furnace temperatures while maintaining low exhaust values, demonstrating how efficiently it uses energy.

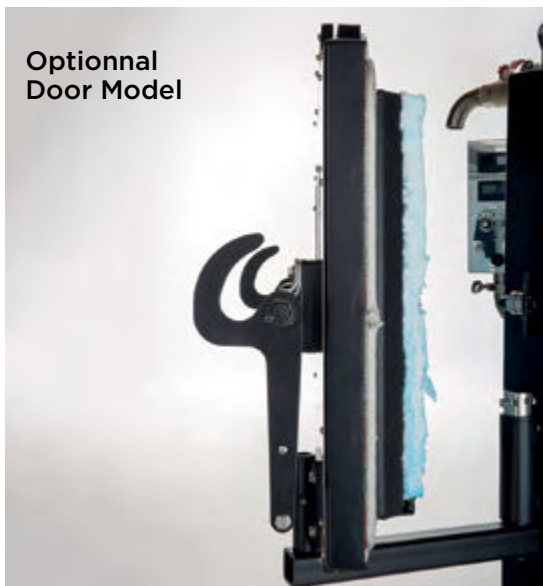

STANDARD FEATURES

- Door is covered with stainless steel on the outside and insulated with high temperature ceramic wool on the inside;
- Clean out doors front and rear;
- Control cabinet can be positioned on either side of the arch;
- Metallic ducts are used for wiring for total protection;
- Factory installed high temperature brick and insulation.



HYPERBRIX® version available

The Force 5 is also able of handling 35 Brix concentrate for fuel economy at its best and make syrup with genuine maple flavor.

EVAPORATORS CONFIGURED FOR 50/50 MORE SYRUP AND MORE FLAVOUR!

OPTIMAL CONFIGURATION FOR A 15 to 30 BRIX CONCENTRATION

Impressively easy to use, the 50/50 configuration evaporators have flat pans of equivalent length to the surface of the flue or tube pans. The optimum configuration to enhance flavour development while saving fuel.

The 50/50 configuration evaporators, combined with a Lapierre R.O., enable a concentrate to evaporate from 15 to 30 Brix, thus allowing a greater amount of syrup to be produced per hour. The ideal choice for medium and large sugar bushes.

The 50/50 configuration is available on our Turbo 3 and Volcano 2000 Series oil fired evaporator as well as on the Force 5 and Fusion wood fired evaporator. Several sizes are available. Ask your maple syrup advisor for more information.

Results of tests carried out with producers in spring 2020

- Equipment: Turbo 3 6' x 20'
- Concentrated: 23,5 Brix
- Average oil consumption:
0.15 gallons per 1 gallon of syrup
- Average production: 211 imperial
gallons or 253 us gallons per hour



A BEAST WITH A GREAT DESIGN

A new high-performance grind based on an ingenious design using the proven technologies of our range of wood-fired Hurricane evaporators. A perfect blend of power and performance for a greater volume of quality syrup.

The FUSION X2 offers above all an improved design, such as the walls of the combustion chamber for more efficient thermal performance. A variable speed air injection and diffusion system provides high operating stability as well as constant uniformity in thermal transfer.

- Available from 2 1/2' x 8' to 6' x 16'
- Available in 50/50 configuration

FUSION X²



AVAILABLE
WITH OPTIFLAM

THE FUSION OF INNOVATION COMBINING PERFORMANCE AND NATURE

BENEFITS

- Very high evaporation performance
- Thermal efficiency and fuel economy
- Ease of operation in the range of 1300 to 1900°F
- More eco-friendly due to its high-performance combustion chamber
- Large combustion chamber capacity, over 300 lbs. of dry wood

SPECIFICATIONS

- Variable speed fan control
- Temperature sensor set and digital display
- Loading door: stainless steel exterior cladding and high temperature ceramic wool insulation
- Factory-installed fire brick and refractory cement furnace
- Preheated air supply for fuel savings

OUR CLASSIC OIL EVAPORATOR: **THE VOLCANO 2000**



OFFERED FROM

- 2 1/2' x 8' à 6' x 16'

Available with Riello variable intensity or Carlin burners.

The Volcano 2000 is one of a kind, it is a machine made with the highest quality standards.

All controls and instruments are easily accessible in the front panel.

The low profile of the furnace allows you to see what is happening inside your syrup pans.

SPECIFICATIONS

- Exterior is completely 304 stainless steel;
- Control switch (high+low), fire on 701 and 801 burners;
- Oil pressure gauge;
- Key type ignition for start up, with security lock;
- In-operation hour meter;
- Port hole allows you to see the flame;
- Junction box allows for a quick and easy hook up of the burners;
- Insulated burner cover to reduce noise;
- Electric plug for thermoregulator and other uses;
- Propane and natural gaz also available.

HYPERBRIX® version available

Featuring the same high-performance evaporator with a configuration of pans enabling efficient and economical evaporation of the concentrate at a very high Brix, while preserving the sensory qualities of maple syrup.



A SUPERIOR EVAPORATION CAPACITY WITH LESS FUEL, FEATURING:

- Double pass for much greater heat transfer under the tube pan;
- Fire tubes are 30% bigger for extreme heat absorption by the pans;
- Slows gas flow for better heat transfer resulting in superior evaporation rate;
- 4 finishing pans design for high concentration and flavour enhancement;
- Fully adjustable boiling intensity;
- Silent operation.



OFFERED FROM

- 2-1/2' x 12' à 6' x 22'

Optional RIELLO burners

The TURBO 3rd Generation evaporators are available with modulating RIELLO burners. Burner modulations allow heat release control to be adapted to the maple concentrate condition.



9" fire tubes for optimal performance and greater heat transfer

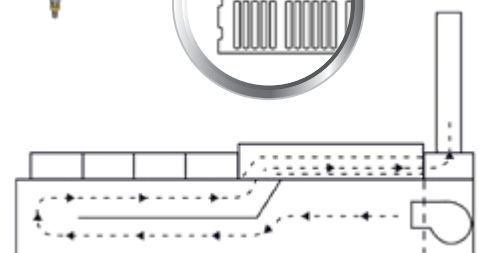
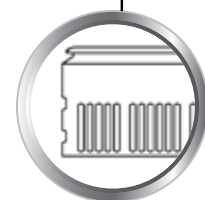

FEATURES

- High energy efficiency;
- Unique flame pattern;
- Heat can vary from 20 % to 100 %;
- Environment oriented european technology;
- The most economical burner on the market;
- Propane and natural gaz also available

Uses less than 1/7 gallon of oil to make one gallon of syrup (at 24 Brix)

HIGH PERFORMANCE TURBO+ PAN

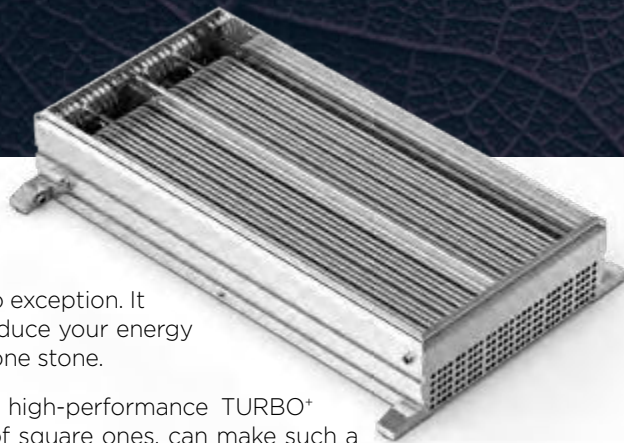

INNOVATIVE ENERGY PERFORMANCE

At **LAPIERRE**, innovation has often made the difference. This time is no exception. It is now possible to easily increase your boiling capacity by 15% and reduce your energy consumption by 10%*. That's what we really call killing two birds with one stone.

Innovative by nature, **LAPIERRE EQUIPMENT** offers its brand new high-performance TURBO+ pan. Would you believe that the simple use of round tubes, instead of square ones, can make such a difference in efficiency? Yes, because it simply increases the heat transfer surface in a pan of the same dimensions.

So, if you have a Turbo 3 or Hurricane F5 Turbo evaporator, it is possible to upgrade directly from a Turbo boiling pan to a **high performance TURBO+ pan** without modifying your evaporator. These pans are available in all sizes for these evaporators.

**Results obtained from a test performed on a Turbo 3 evaporator, dimensions 6 x 16 ft., having a 50/50 pan configuration..*

BOILING CAPACITY	15% increase
ENERGY CONSUMPTION	10% reduction
COMPATIBLE MODELS without any modification	Turbo 3 and Hurricane F5 Turbo
AUTOMATED PAN WASHER	Compatible

WHY DOES THIS INNOVATION MAKE A DIFFERENCE IN YOUR LIFE AS A MAPLE SYRUP PRODUCER?

Because your evaporator is 10% more efficient; because it uses 10% less energy to produce the same gallon of syrup; because you make 10% more syrup with the same amount of energy; because you make 10% more syrup in an hour or in a day; in fact, no matter how you look at it... you are making 10% more.

PATENT PENDING



TESTIMONIAL

*Stéphane Verville, HURRICANE F5
Turbo, 6 x 16 ft., 50/50 configuration*

Here are the first impressions of Stéphane Verville, owner of Passion agricole in Saint-Christophe-d'Arthabaska, Quebec: "Compared to the standard tubes pan, the TURBO+ gives us a very different boiling pattern. The distribution is much more even and the boiling is less aggressive, which reduces the use of antifoam."

Mr. Verville also brings some interesting findings to the use of round tubes for the TURBO+ rather than square ones: "It is surprising to see how much less solid deposits accumulate on round tubes. The expansion and contraction caused by the cold and heat naturally loosens the Sugar sand that have accumulated on the round tubes, which then fall off and go into the decanter. This reduces the need for acids and also reduces the time needed to clean the system. Finally, the superior heat exchange brings an appreciable increase in evaporation."

The Classic

AVAILABLE SIZES

- 2' x 6'
- 2' x 8'
- 2' x 10'

AVAILABLE OPTION

- Pan covers



Picture shows
2' x 6'

SPECIFICATIONS

- 7" raised flues;
- Arch: cast iron front, stainless sides;
- 20 g. walls, 22 g. flues #304 stainless;
- Smoke stack included (2 x length of the evaporator including base pipe);
- Cold and hot float boxes;
- Stainless heavy duty interconnections;
- Draw off ball valve included;
- Fire bricks and insulation kit not included.

The Barrel

These hobby evaporators with a flat bottom pan are designed for those who want to have fun while making maple syrup for their own use. Less efficient compared to a larger evaporator, we recommend using a finisher.

AVAILABLE SIZES

- 24" x 36" (20 to 50 taps)

SPECIFICATIONS

- 22 g. #304 stainless flat bottom pan, 3 compartments;
- Arch: 16 gauge steel;
- Includes 90 deg 6" elbow for chimney;
- #304 stainless pre-heater pan, 9" x 22";
- 3/4" draw off ball valve included;
- Fire bricks not included.



Propane Evaporator



AVAILABLE SIZES

- 16" x 48" (10 to 30 taps)

SPECIFICATIONS

- Gas stove with three 65 000 BTU burners;
- 16" x 32" flue pan (4" flues) with float box;
- 16" x 16" syrup pan with float box;
- Propane tank not included (For outside use only).



OPTIFLAM^{MD}

combustion controller

CONTROLLER	CODE
Optiflam automated combustion controller	FF200-000001XX

FOR OPTIMAL EFFICIENCY & MINIMAL WOOD CONSUMPTION

OPTIFLAM is an automated system for supporting the thermodynamic properties of the evaporator combustion chamber to optimize heat using a minimum amount of fuel.

- Measures various operating conditions to determine the best evaporator operating conditions.
- Adjusts fan speed continuously to maintain the temperature set by the operator.

TOUCH SCREEN DISPLAY

OPTIFLAM is equipped with an easy-to-use 7.5 inch (19.5 cm) touch screen to access the various functions of the combustion manager.

Combustion statistics on the evaporator combustion settings are compiled and displayed on the screen:

- The operating time.
- The average temperature maintained.
- The time between reloads
- The time required to recharge.
- Temperature set by the operator.

BENEFITS

- The OPTIFLAM provides automated operation of your evaporator in order to maintain optimal and constant heat without any need for assistance on your part.
- The operator's only involvement is putting wood into the combustion chamber when indicated on the display.
- This minimizes flow interruptions and improves syrup quality.
- Allows control over the amount of fuel used.

3 OPERATING MODES

AUTOMATIC MODE

- OPTIFLAM takes care of the evaporator
- Adjusts Fan speeds
- Gives wood reload warning
- Monitors combustion and stops fan operation at the end of production

MANUAL MODE

The operator controls the fan speed directly, as with a standard Hurricane, but from the control screen.

MECHANICAL MODE

The operator controls the fan speed directly, as with a standard forced air evaporator, using rheostats, but from the control box.

Integrates with lapierre forced air - wood fired evaporator on existing or brand new devices



Fire and performance for hobby and small business operations.



WOOD FIRED EVAPORATORS EXCEPTIONAL VISION



VISION

EXCEPTIONAL VISION

This line of evaporators offers you exceptional vision:

- With a full size airtight door and air cooled for a better efficiency
- Of the inside of the arch for an unprecedented feel in your *Sugar Shack*
- With its classic, sleek design and state-of-the-art technology
- Thanks to its newly-engineered combustion chamber

Our VISION line is designed for hobby or smaller sugar makers or those without electricity. It offers producers high performance, high efficiency and amazing ease of operation.

PRACTICAL FEATURES FOR AN INFORMED DECISION:

- Enclosed ash box allows for installation on any surface
- Adjustable legs for multiple height options and ease of leveling
- “Comfortable” working height, even for small models
- Single door giving access to the arch and ash box
- Stainless steel ultra-chic design
- Easy to clean
- Cooled arch door handle

VISION 18 & 24 in EVAPORATORS WITH INNOVATIVE DRAW-OFF PANS:

- Perfect for beginners and intermediates
- Remarkable boiling distribution
- One single control level - or float - rather than two



OUR NEW AIRTIGHT COMBUSTION CHAMBER IS THE CORE OF OUR PERFORMANCE

Large arch capacity:

- Reduces the number of refills per hour

Airtightness achieved by:

- With fully gasketed door as well as gasketing between the arch and pans.
- An optional seal between each pan

Airtightness for:

- Faster start-up
- Better burn rate control
- Less cold air ingress for increased performance
- Performance equal to or better than current models of the same capacity
- Less fuel

Energy efficient to:

- Significantly reduce heat loss and energy consumption
- Optimize the amount of energy used for syrup production

Choice of lines:

The VISION line offers you several possibilities regarding the equipment included with your evaporator.

From the basic model to the top of the line, each of them has what it takes to produce high quality maple syrup.

Dimensions :

18 x 48 in*	30 x 120 in
18 x 60 in*	36 x 120 in
24 x 72 in*	36 x 144 in
24 x 96 in	
24 x 120 in	

Patent pending |



Warranty

Two-year limited warranty on parts and labor

*Available dimensions for innovative draw-off pans.

*Dimension disponible avec panes à bouillir innovantes

High Pressure Pan Washer

The natural solution to save time and cleaning products

This system provides continuous, non-contact washing to remove stubborn stains

- For both flue and syrup pans
- 5 HP recirculation pump
- Entirely made of stainless steel
- 4 or 5 Belimo valves depending on the size of the evaporator
- Use in automated and sequential mode or in manual mode
- Up to 5 programmable washing sequences
- Tank with filtration screen, splash-proof Lexan and non-slip metal plate used as a step

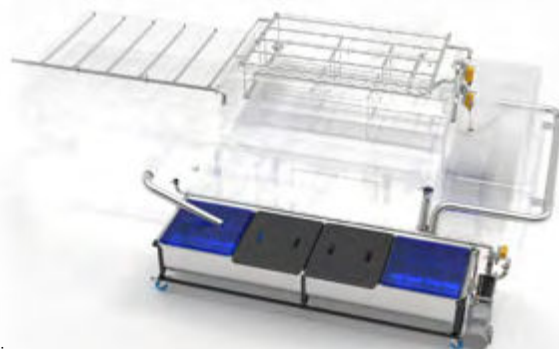

SYRUP PAN OPTION

Stainless steel tube with nozzles that can remain in place during operation.
 Splash proof Lexan cover

Recessed covers with sprinklers (Lapierre syrup pan)

Available from 2 to 9 sprinklers for syrup pans 18" x 36" up to 72" x 72"

For pans other than Lapierre, you must provide internal dimensions and contact us for details

PAN WASHERS FOR RECESSED COVERS WITH SPRINKLERS	CODE
Complete pan washer 24" reservoir	EV051-000024XX
Complete pan washer 48" reservoir	EV052-000048XX
Complete pan washer 72" reservoir	EV053-000072XX

All tanks include 1 Goulds pump and 1 filter:
 For 24" and 48" tanks = 1/2 HP pump;
 For 72" tank = 1 HP pump.
 Cover not included.



OPTIONS	CODE
Auto-Stop by pressure	EL049-281102XX
Stainless steel sprinkler only with acetal adaptor	EV250-000000XX
Filter only 1 1/2"	EV250-000002XX

RECESSED COVER WITH SPRINKLERS (LAPIERRE PAN)	CODE
Cover 2 sprinklers for pan 30" x 18"	EV050-023018XX
Cover 2 sprinklers for pan 36" x 18"	EV050-023618XX
Cover 2 sprinklers for pan 36" x 20"	EV050-023620XX
Cover 2 sprinklers for pan 36" x 24"	EV050-023624XX
Cover 2 sprinklers for pan 42" x 18"	EV050-024218XX
Cover 2 sprinklers for pan 42" x 20"	EV050-024220XX
Cover 2 sprinklers for pan 42" x 24"	EV050-024224XX
Cover 2 sprinklers for pan 48" x 20"	EV050-024820XX
Cover 2 sprinklers for pan 48" x 24"	EV050-024824XX
Cover 3 sprinklers for pan 60" x 18"	EV050-036018XX
Cover 3 sprinklers for pan 60" x 24"	EV050-036024XX
Cover 3 sprinklers for pan 72" x 24"	EV050-037224XX
Cover 4 sprinklers for pan 48" x 48"	EV050-044848XX
Cover 6 sprinklers for pan 48" x 72"	EV050-064872XX
Cover 6 sprinklers for pan 60" x 48"	EV050-066048XX
Cover 6 sprinklers for pan 72" x 48"	EV050-067248XX
Cover 9 sprinklers for pan 60" x 60"	EV050-096060XX
Cover 9 sprinklers for pan 72" x 72"	EV050-097272XX

REVERSE FLOW KIT

Allows you to draw syrup all day without changing your cross flow pans.

Fits wood or oil evaporators. Includes: ball valves and fittings to connect "HOT" float box to rear and front inlets. You will be ready to draw syrup in less than 5 minutes (requires 3 to 4 syrup pan configuration). Optional: all stainless steel ball valves.

CENTRAL DRAW-OFF KIT

Allows you to draw syrup without moving the syrup tank when using the draw-off inversion kit.

2" SIGHT LEVEL

This sight level makes reading much easier and accurate than ever before. Available for syrup and flue pans.

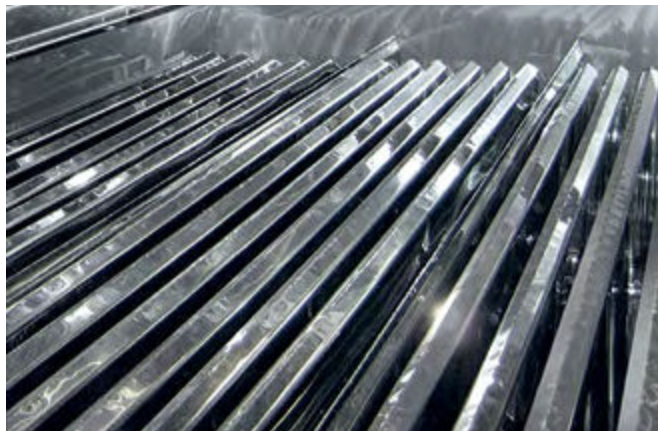

7" AND 9" HIGH DIAMOND POINT FLUES

Made with 304BA (Bright annealed) SS and available on Force 5, Fusion and Volcano 2000, the new diamond point flues will make your flue pan easier to clean.

DIRECT ACTION FLOAT BOXES

Direct action float boxes for accurate and fast sap transfer and precise pan level control.



6 COMPARTMENT SYRUP PAN WITH BUILT IN REVERSE FLOW KIT AND CENTRAL DRAW-OFF KIT

This pan evaporator by replacing 3 to 4 syrup pans, by saving on stainless.

The central draw-off allows you to draw syrup without moving the syrup tank when using the draw-off inversion kit.

SAFETY,
it's a family affair!

**NOW OFFERING
HIGH QUALITY
CHIMNEY
SOLUTIONS**

**DID YOU KNOW THAT
A FAULTY CHIMNEY INSTALLATION
MAY CAUSE A FIRE?**

Your single wall chimney must;

- Provide 24 inches clearance to a combustible wall.
- Provide 18 inches clearances to any combustible material.
- Stack termination must be 10ft higher than any obstacle in a 20ft radius.

**LAPIERRE EQUIPMENTS IS NOW OFFERING
A DOUBLE WALL INSULATED LISTED CHIMNEY**

- UL103HT listed chimney.
- Specifically designed for the Maple Industry.
- Needs only 2 inches clearance to any combustible material.
- Must be 3ft above any obstacle in a 10ft radius (therefore permitting shorter run, saving cost).
- Allow the use of a smaller diameter chimney for the same evaporator, (saving cost).
- RECOGNIZED BY YOUR INSURANCE COMPANY.



MAPLE SYRUP AUTO CONTROL

- Made by Lapierre;
- High precision;
- Fast reaction and reliable;
- Removable actuator and control box;
- Programmable to adapt to evaporator size;
- Easy to wash;
- Manual or auto mode;
- Probe included;
- Heavy duty SS clamp and gasket required.



**LAPIERRE
EXCLUSIVE**

LAPIERRE MODULATING DRAW-OFF	CODE
Ferrule 1 1/2" outlet (1 probe)	DV122-240001XX
Ferrule 1 1/2" outlet (2 probes)	DV122-240002XX
1 1/2" replacement rubber gasket	DV322-000024Q1
Elbow, 90°, 1 1/2" (optional)	EV707-902424S2
Ferrule 2" outlet (1 probe)	DV122-000001XX
Ferrule 2" outlet (2 probes)	DV122-000002XX
2" replacement rubber gasket	DV322-000032Q1
Elbow, 90°, 2" (optional)	EV707-903232S2

A - DISPENSER AUTO	CODE
For liquid de-foamer	DV168-000000XX
Replacement pump	PM568-240104XX

SONDE SUPPORT	CODE
For Lapierre controller modulating draw-off	DV522-000001S3

B - SS ROPE OPERATED STACK COVER
Available for smoke stack and steam stack in all sizes. Price upon request

C - PEAK STYLE COVER
Available for smoke stack and steam stack in all sizes. Price upon request

A



B



C



A



B



C



D



E



F



G



H



I

MISCELLANEOUS	CODE
A - 8 1/4" digital thermometer	EITB0012
B - 12" SS back thermometer	EITDT158
C - 18" thermometer	EITBC018
Replacement stem for 18" thermometer	EITRC018
D - 5" barometer	DV010-001353XX
E - Maple syrup digital grader HI759	DV024-000759XX
F - Lovibond Comparator (New grading system)	DV034-433240XX

CENTRE ACER	CODE
H - Grading kit of IISE/IMS for new classification	DV028-000000NX
I - 1 oz simple bottle	EICOL016

J - DIAL THERMOMETER	CODE
3" dial 1/4" thread, 6" stem 0-50 deg. F	EITC0306
3" dial 1/4" thread, 9" stem 0-50 deg. F	EITC0309
3" dial 1/4" thread, 12" stem 0-50 deg. F	EITC0312
5" dial 1/4" thread, 9" stem 0-50 deg. F	EITC0509
5" dial 1/2" thread, 9" stem 0-50 deg. F	EITC5509
3" dial 1/2" thread, 9" stem 0-250 deg. F	EITC0325
3" dial 1/2" thread, 6" stem 50-300 deg. F	EITC0336
3" dial 1/2" thread, 9" stem 50-300 deg. F	EITC0330
3" dial 1/2" thread, 18" stem 50-300 deg. F	EITC0318
5" dial 1/2" thread, 12" stem 50-300 deg. F	EITC0512
3" dial 1/2" thread, 2 1/2" stem 200-1000 deg. F	DV267-084048XX
3" dial 1/2" thread, 4" stem 200-1000 deg. F	DV267-086448XX

Tips for measuring the efficiency of your wood-fired evaporator



Érablé & Chalumeaux



It's not uncommon for maple syrup producers to have difficulty determining the efficiency of their wood-fired evaporators. Many feel they are using more wood than they should. But are they really?

A balance between evaporation rate and wood consumption

First of all, we often aim for the highest syrup output per hour. To achieve a very high evaporation rate, we have to operate the evaporator at maximum efficiency, with a high residual heat output through the chimney, which reduces thermal efficiency. It's like overheating the outside! This is how many maple syrup producers consume a little too much wood for their maple syrup production, so it's important to strike a balance between an efficient evaporation rate and reasonable wood consumption.

Temperature of the exhaust gases in the chimney

To find this balance, it's important to know the temperature of the exhaust gases in the chimney. As an example, in our new facilities, we obtain equal boiling in all the pans when the temperature in the chimney is around 700°F (371°C). The combustion chamber then stays between 1,400 and 1,500°F (760 and 816 °C) which, according to our ex-

periments, is a good balance. As each evaporator is unique, air circulation must be adjusted accordingly.

Wood: moisture content and weighing, calorific value and density



To achieve optimum evaporation per cord of wood burned, you need high-quality wood with a moisture content of less than 20%.

Not all types of wood have the same calorific value, as their density differs. For example, a sugar maple cord has twice the calorific value of a balsam fir cord. The easiest way to determine the calorific value of your wood is to determine the average moisture content of a sample of logs and weigh the wood used for evaporation. If the wood has a moisture content of around 20%, it will therefore generate 5,780 BTUs per pound of wood consumed in the evaporator (reference value), regardless of whether it comes from softwood or hardwood.

Compromise between production speed and wood consumption



At Érablé & Chalumeaux, we weigh our wood racks before the start of boiling and at the end. That way, we know the total pounds of wood we have burned. Next, we need to determine how much water has been evaporated. To do this, we know the volume of concentrate and its starting Brix degree, which enables us to determine the total amount of water evaporated for the concentrate to reach 66 Brix syrup.

Thanks to these measurements, we can determine an evaporation rate per hour based on the amount of wood used. The goal of such measurements is to find the best compromise between maple syrup production speed and wood consumption.



Edith Bonneau et Stéphane Guay
Biologists

SUNFLOWER OIL	CODE
Deodorized organic sunflower oil (1.5 liters)	DV508-001500XX
Deodorized organic sunflower oil (10 liters)	DV508-000010XX

BIO SUNFLOWER OIL, ODORLESS, CERTIFIED KOSHER & ECOCERT	CODE
1 liter	DV509-000001XX
4 liters	DV509-000004XX



DEFOAMER	CODE
Kasher defoamer (200 g)	DV406-000200LA
Liquid defoamer (8 oz)	EVAN108W
Liquid defoamer (32 oz)	EVAM032W
Liquid defoamer (128 oz)	EVAM128W



ATAGO	CODE
60-70 brix (syrup)	DV012-006070XX

Developed especially for maple syrup

- 60 to 70 Brix scale easier than ever to read;
- Built-in protection against dust and water.

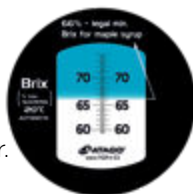

CENTRE ACER	CODE
Calibration solution 66.0 brix (for refractometer)	DV137-000660XX



HYDROMETER AND HYDROTHERM	CODE
Hydrometer 0-35 Brix (sap)	DV020-000035XX
Hydrometer 45-75 Brix (syrup)	DV020-004575XX
Robi density for hydrotherm (1 liter)	DV426-000001XX
Hydrometer 0-15 Brix (sap)	DV020-000015XX
Hydrometer 50-70 Brix (syrup)	DV020-005070XX
Hydrotherm red column	DV023-000000XX



HYDROMETER AND HYDROTHERM CUP	CODE
Hydrometer cup 1 1/2" x 14" WITH BASE	DV025-002414ST
Hydrotherme cup 2" x 12" WITHOUT BASE	DV025-003212ST
Hydrotherme CUP 2" x 14" WITHOUT BASE	DV025-003214ST



DEFOAMER CUP (LAPIERRE)	CODE
Defoamer cup 1"	DV045-000001S2
Defoamer cup 1 1/2"	DV045-000002S2



DEFOAMER CUP (WATERLOO)	CODE
1" with 4"	DV045-000005S2
1" with 10"	DV045-000003S2
2" with 10"	DV045-000004S2



ROUND SYRUP FILTER TANK WITH TOP LID	CODE
5 gal (9" dia. x 22" height)	EM115-092205ST
15 gal (14" dia. x 27" height)	EM115-142715ST
24 gal (18" dia. x 27" height)	EM115-182724ST
40 gal (23" dia. x 27" height)	EM115-232740ST
Base on casters for 15-24-40 gal	EM315-010000ST

* Filter holder not included



FILTER	CODE
#8 filtration cone	EVBO008W
#8 filtration cone seamless	EVBF008W
#8 poly. prefilter, 12/pack	EVPAT008
Filtration material 36" x 36"	EVCO3636
Polyester paper 36" x 36", 12/pack	EVPA3636



Cover optional

DUAL SQUARE TANKS ON CASTERS WITH VALVE				CODE
18" x 18" x 32"	2 x 27 imp. gal	2 x 32 USG	21" x 39" x 32" (Overall)	EM160-181832S3
18" x 24" x 32"	2 x 35 imp. gal	2 x 42 USG	21" x 51" x 32" (Overall)	EM160-182432S3
18" x 36" x 32"	2 x 53 imp. gal	2 x 63 USG	21" x 75" x 32" (Overall)	EM160-183632S3
24" x 24" x 32"	2 x 50 imp. gal	2 x 60 USG	27" x 51" x 32" (Overall)	EM160-242432S3
24" x 36" x 32"	2 x 75 imp. gal	2 x 90 USG	27" x 75" x 32" (Overall)	EM160-243632S3

TRIPLE SQUARE TANKS ON CASTERS WITH VALVE				CODE
18" x 18" x 32"	3 x 27 imp. gal	3 x 32 USG	21" x 57" x 32" (Overall)	EM161-181832S3
18" x 24" x 32"	3 x 35 imp. gal	3 x 42 USG	21" x 75" x 32" (Overall)	EM161-182432S3
24" x 24" x 32"	3 x 50 imp. gal	3 x 60 USG	27" x 75" x 32" (Overall)	EM161-242432S3

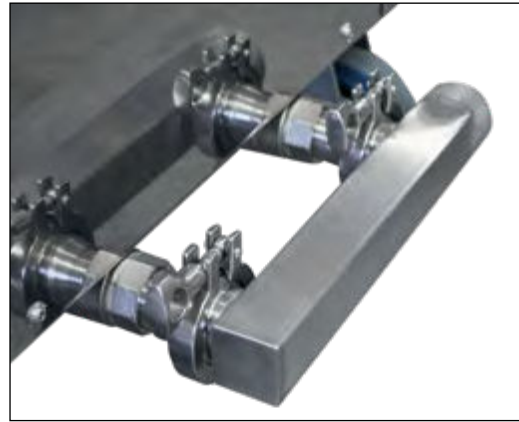

SYRUP TANK WITH CONE FILTERS	CODE
Rectangular syrup tank (24 gallons) with cover and support for three cone filters (#8 cone filters not included)	EM174-122436S3

OPTIONS FOR SQUARE TANKS ON CASTERS	CODE
SS outlet option 1" x 1" x 1 1/4" (MPT x MPT x FPT)	EM360-161620S2
SS outlet option 1" x 1" x 1" x 1 1/4" (MPT x MPT x MPT x FPT) for triple tanks on casters	EM361-161620S2



Stainless steel outlet optional

DUAL SQUARE TANKS ON CASTERS WITH VALVE AND SKIRT				CODE
18" x 18" x 32"	2 x 27 mp. gal.	2 x 32 USG	21" x 39" x 32" (Overall)	EM170-181832S3
18" x 24" x 32"	2 x 35 mp. gal.	2 x 38 USG	21" x 51" x 32" (Overall)	EM170-182432S3
18" x 36" x 32"	2 x 53 mp. gal.	2 x 63 USG	21" x 75" x 32" (Overall)	EM170-183632S3
24" x 24" x 32"	2 x 50 mp. gal.	2 x 60 USG	27" x 51" x 32" (Overall)	EM170-242432S3
24" x 36" x 32"	2 x 75 mp. gal.	2 x 90 USG	27" x 75" x 32" (Overall)	EM170-243632S3

TRIPLE SQUARE TANKS ON CASTERS WITH VALVE AND SKIRT				CODE
18" x 18" x 32"	3 x 27 mp. gal.	3 x 32 USG	21" x 57" x 32" (Overall)	EM171-181832S3
18" x 24" x 32"	3 x 35 mp. gal.	3 x 38 USG	21" x 75" x 32" (Overall)	EM171-182432S3

DUAL INSULATED SQUARE TANKS ON CASTERS WITH VALVE AND SKIRT				CODE
18" x 24" x 32"	2 x 35 mp. gal.	2 x 38 USG	21" x 51" x 32" (Overall)	EM190-182432S3

Filter press

7" SQUARE FILTER PRESS	CODE
7" filter press, 3 hollows, 2 plates, with pumping unit diaphragm electric 1/2"	SR012-030207XX
7" filter press, 3 hollows, 2 plates, w/o pumping unit and w/o swivel support	SR010-030207XX
7" filter press, 8 hollows, 7 plates with pumping unit diaphragm electric 1/2"	SR012-080707XX
7" filter press, 8 hollows, 7 plates, w/o pumping unit and w/o swivel support	SR010-080707XX
7" filter press, 10 hollows, 9 plates with pumping unit diaphragm electric 1/2"	SR012-100907XX
7" filter press, 10 hollows, 9 plates, w/o pumping unit and w/o swivel support	SR010-100907XX
Add hollow and plate for 7" square filter press	SR011-000007XX

10" SQUARE FILTER PRESS	CODE
10" filter press, 3 hollows, 2 plates with pumping unit diaphragm electric 1/2"	SR012-030210XX
10" filter press, 3 hollows, 2 plates, w/o pumping unit and w/o swivel support	SR010-030210XX
10" filter press, 7 hollows, 6 plates with pumping unit diaphragm electric 1/2"	SR012-070610XX
10" filter press, 7 hollows, 6 plates, w/o pumping unit and w/o swivel support	SR010-070610XX
10" filter press, 10 hollows, 9 plates with pumping unit diaphragm electric 1/2"	SR012-100910XX
10" filter press, 10 hollows, 9 plates, w/o pumping unit and w/o swivel support	SR010-100910XX
Add hollow and plate for 10" square filter press	SR011-000010XX

FRAME	CODE
7" and 10" stainless steel standard swivel frame with robust wheels (not included with the purchase of a press)	SR405-000002XX

You can add plates according to your needs on our square filter press.

UPON PURCHASE OF A COMPLETE FILTER PRESS W/O PUMPING UNIT:

- Hoses, connections and pan
- 3/4" ball valve for the pan



15" SQUARE FILTER PRESS	CODE
15" filter press, 6 hollows, 5 plates w/o pumping unit	SR010-060515XX
15" filter press, 7 hollows, 6 plates w/o pumping unit	SR010-070615XX
15" filter press, 8 hollows, 7 plates w/o pumping unit	SR010-080715XX
15" filter press, 9 hollows, 8 plates w/o pumping unit	SR010-090815XX
15" filter press, 11 hollows, 10 plates w/o pumping unit	SR010-111015XX
15" filter press, 12 hollows, 11 plates w/o pumping unit	SR010-121115XX
15" filter press, 13 hollows, 12 plates w/o pumping unit	SR010-131215XX
Add hollow and plate for 15" square filter press	SR011-000015XX

PUMPING UNIT OPTION FOR 15" SQUARE FILTER PRESS	CODE
1/2" Yamada diaphragm pumping unit	SR003-150008NX
1" Yamada diaphragm pumping unit	SR003-150016NX

SHELF & VALVE OPTION FOR 15" FILTER PRESS	CODE
shelf option for Yamada & Y51 pumping unit (only on purchase of a 15" square filter press with pumping unit)	SR405-150237TX
3 way valve option with ss JIC 3/4" adaptor	SR405-151212KJ
3 way valve option with 1/2" quick coupling female & pressure gauge for pump 1/2"	SR405-151208KR

DIAPHRAGM PUMPING UNIT	CODE
Yamada diaphragm syrup pump 1/2"	SR003-000008NX

Each pumping unit includes pressure and bypass hoses.

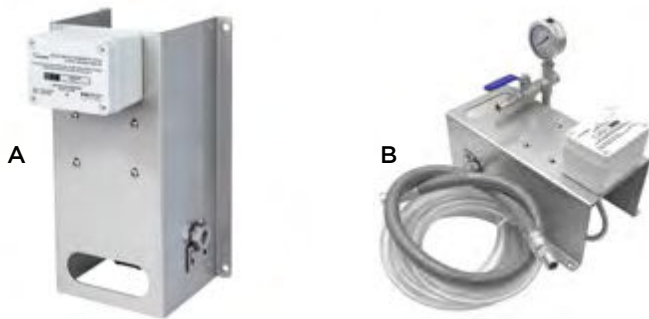

ELECTRIC DIAPHRAGM PUMPING UNIT	CODE
A - Pumping unit diaphragm electric 3/8"	SR003-000008EX
B - Pumping unit diaphragm electric 1/2" including connection hose	SR003-000008KT

REPLACEMENT DIAPHRAGM PUMP	CODE
Yamada diaph. syrup pump 1/2" 4 gal/min @ 50 PSI, 7 SCFM	PM066-000008A1
Yamada diaph. syrup pump 1" 25 gal/min @ 50 PSI, 25 SCFM	PM066-000016A1
1/4" regulator filter for diaphragm syrup pump	PM204-534221XX

KIT OF REPAIR	CODE
Liquid repair kit for Yamada diaphragm pump 1/2" model NPD-15BAH	PM206-080015KTMH
Liquid repair kit for Yamada diaphragm pump 1" model NPD-25BAH	PM206-160025KTMH
Liquid repair kit for Yamada diaphragm pump 1/2" model G15AH11	PM266-080015KTMH
Liquid repair kit for Yamada diaphragm pump 1" model G25AH11	PM266-160025KTAH
Repair kit for diaphragm flojet pump 115 V, 6.0 GPM, 75 PSI, 1/2"	PM256-000000KT



POMPCO S-275 ALL STAINLESS HEAD	CODE
Syrup filter pumping unit (includes pressure and bypass hoses)	SR003-000275XX



RESTRICTION PLATE FOR SQUARE FILTER PRESS	CODE
SS 10" plate	SR405-101832S4
SS 15" Plate	SR405-151632S4



Filter cloth



Diatomaceous earth



Filter paper



Restriction plate



Double hollow

ACCESSORIES	CODE
12" Washable filter cloth 1 micron (pkg/2)	DV400-011202XX
12" Washable filter cloth 5 microns (pkg/2)	DV400-001202XX
24" Washable filter cloth 5 microns (pkg/1)	DV400-002401XX
O'ring #253, 5-3/8"	DV201-000253XX
Dicalite Diatomaceous earth (filter aid) 10 lb	DV403-010010XX
Dicalite Diatomaceous earth (filter aid) 50 lb	DV403-010050XX
White filter papers 7" (box/400)	DV404-000007XX
White filter papers 10" (box/400)	DV404-000010XX
White filter papers 15" (box/250)	DV404-000015XX
6' translucent tubing assembled with SS hook and fitting 1/2"	SR200-000027XX
6' translucent tubing assembled without SS hook and fitting 1/2"	SR200-000027AX

DOUBLE HOLLOW PLATES	CODE
Double hollow plate 7" (o'rings not included)	SR405-070008RX
Double hollow plate 10" (o'rings not included)	SR405-100007RX

Available on 7" and 10" presses. By removing plates or lengthening the press, the addition of double frames allows for greater filtration capacity.

Sirofilter

SIROFILTER	CODE
12" Sirofilter complete w/o pumping unit	SR002-000012XX
12" Sirofilter complete with pumping unit diaphragm electric 1/2"	SR001-080012EX
24" Sirofilter complete w/o pumping unit	SR002-000024XX
24" Sirofilter complete with pumping unit diaphragm electric 1/2"	SR001-080024EX

UPON PURCHASE OF A COMPLETE SIROFILTER W/O PUMPING UNIT:

- Hoses, connections and pan;
- 3 washable filter cloths.

**LAPIERRE
EXCLUSIVE**



**STAINLESS STEEL
EXTERIOR**

Pneumatic bottler system



Bottling valve kit



Bottling valve only

LAPIERRE PNEUMATIC BOTTLER SYSTEM	CODE
Lapierre pneumatic bottler system with manual control (bottling valve and tablet not included)	EM100-160102KT
Lapierre pneumatic bottler system with digital control (bottling valve and tablet not included)	EM100-160102CN
Option bottling valve 10 mm	EM306-062410KT
Option bottling valve 15 mm	EM306-062415KT
Lapierre pneumatic single bottler system with manual control and bottle guide (bottling valve not included)	EM306-020506CMS

OPTIONS	CODE
Option SS shelf (18")	EM306-161804KT
Bottling valve 10 mm	EM245-062410XX
O'ring and U-cup kit for bottling valve 10 mm	DV201-100245XX
Bottling valve 15 mm	EM245-062415XX
O'ring and U-cup kit for bottling valve 15 mm	DV201-150245XX

Example: To order a pneumatic bottler system with 4 bottling valves, you should use the code of the bottler system and 4 times the code of the option bottling valve.

Syrup water jacketed tanks

SYRUP WATER JACKETED TANKS	CODE
10 gal (12 USG) 20" x 16" 1 x 3000 W 2 syrup outlets	EM140-000010ST
Stand with adjustable shelf	EM340-201600ST
24 gal (29 USG) 32" x 20" 2 x 3000 W 4 Syrup outlets	EM140-000024ST
Stand with adjustable shelf	EM340-322000ST
34 gal (41 USG) 34" x 24" 2 x 3000 W 4 Syrup outlets	EM140-000034ST
Stand with adjustable shelf	EM340-342400ST
50 gal (60 USG) 38" x 28" 2 x 3000 W 4 Syrup outlets	EM140-000050ST
Stand with adjustable shelf	EM340-382800ST



10 gal (12 USG)



50 gal (60 USG)



HEATING ELEMENT (240 VOLTS)	CODE
3000 W element with temp. control	EM340-013000XX

GAS BURNER AND BOTTLING PAN

Complete kit: stand, burner, 16" x 16" stainless pan, outlet, filter rack, 3/4" draw off valve thermometer fitting 1/2", top lid and adjustable shelf.

GAS BURNER AND BOTTLING PAN	CODE
Complete kit	PE090-161600ST
Stainless bottling pan stand with adjustable shelf	FF016-161600ST
Gas burner with hose and regulator	ECRG016W
Mini steam pan (optional)	PP025-171701ST

SYRUP PANS (COVER AND OUTLET NOT INCLUDED)	CODE
16" x 16" x 14" (10" = 9.2 gal/11 USG)	PP009-161605ST
16" x 16" (3/4" outlet, nipple, ball valve, elbow, 1/2" dial fitting and plug included)	PP009-161607ST

8" or 10" = pan water level

SYRUP PAN OPTIONS	CODE
Pan cover 16" x 16"	PP027-161600ST
Syrup outlet 3/4" with valve and elbow (installed)	CS001-060006ST
Filter rack for 16" x 16" pan	PP027-161602S2



Mini steam pan



Cover not included

Propane Finisher

AVAILABLE SIZES

- 16" x 48"

SPECIFICATIONS

- 3- 16" X 16" Propane stoves of 65,000 BTU each maximum;
- 1-Stainless steel finishing pan with flat bottom 16" X 48" X 14" High, no partition;
- 3/4" ball valve with elbow included;
- NO float box;
- Propane tanks not included (For outside use only).





A



B



C



D

NEW



E



F

MAPLE JELLY POWDER	CODE
Genugel 200 g	EM399-000200GR

CAN SEALER	CODE
A - IVESWAY auto-manual can sealer	ECMAY700
B - MASTER auto-manual can sealer	ECMAM200
C - Automatic Lapierre can sealer (120 volts)	EM100-000001XX
D - Automatic can sealer	EM100-000009XX

E - MAPLE CREAM MAKER 1/2 HP	CODE
The 1/2 HP model with stainless steel gear driven pump operates on regular 120 volts and is perfect for the amateur who wants a butter as smooth and creamy. Perfect to the producer making just a few hundred containers per season.	EM100-00000456

F - MAPLE CANDY MACHINE	CODE
A motor driven auger mixes the maple sugar with perfect consistency and feeds the candy mold (120 volts).	PP024-000001ST



SCAN THE QR CODE to discover our complete variety



ELAPIERRE.COM
Online Store

- Full range of metric and standard sizes;
- Generic labels for Provinces and States;
- Tamper-evident caps with oxygen barrier foil liner;
- Distinctive trademarked traditional shape;

- Made from food-safe FDA approved recyclable resins;
- Colorful private label screen-printing available;
- Proprietary available XL Coating to maintain grade stability.



USA		CODE
1 USG	24/BOX	EXCR4000
1/2 USG	32/BOX	EXCR2000
Quart	90/BOX	EXCR1000
Pint	100/BOX	EXCR0510
1/2 pint	100/BOX	EXCR0260
3,4 oz	100/BOX	EXCR0100

CANADA		CODE
4 L	24/BOX	EM022-004024CA
2 L	32/BOX	EM022-002032CA
1 L	90/BOX	EM022-001096CA
500 ml	100/BOX	EM022-500100CA
250 ml	100/BOX	EM022-250100CA
100 ml	100/BOX	EM022-100100CA



BOTTLES	CLOSURES NOT INCLUDES	CODE
Maple leaf, 50 ml	18 mm	EM035-050048XX
Maple leaf, 100 ml	24 mm	EM035-100012XX
Maple leaf, 250 ml	24 mm	EM035-250012XX
Maple leaf, 550 ml	28 mm	EM035-500012XX

BOTTLES	CLOSURES NOT INCLUDES	CODE
Kent, 250 ml	28 mm	EM048-010250XX
Kent, 375 ml	28 mm	EM048-010375XX

Bottle pictures are for reference only.
Bottles sold by the case only.



Drum (1 hem)



Drum (2 hems)



Drum truck

STAINLESS STEEL INOVAWELD DRUMS			CODE
22 imp. gal. (26 USG)	301-2B with 2 hems	29,75" high x 17,50" dia. ins.	BR001-002922S9
34 imp. gal. (40 USG)	301 with 1 hem	29,75" high x 20,75" dia. ins.	BR001-002934S9BX
34 imp. gal. (40 USG)	304-2B with 2 hems	29,75" high x 20,75" dia. ins.	BR001-002934S4
45 imp. gal. (54 USG)	301-2B with 2 hems	35,00" high x 22,60" dia. ins.	BR001-003545S9
3/4" standard cap			BR408-010012J1
2" standard cap			BR408-010032J1
2" gasket			BR431-000032XX
Drum truck			BR005-000000XX
Drum tagging (maximum 14 characters)			BR004-000014XX

Cap 2" and 3/4" included on the cover (can be on the periphery of the cover instead of the center).



A

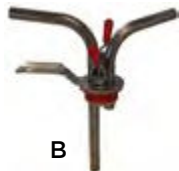

B



C

ACCESSORIES	CODE
A - Stainless steel pail 4 liters	DV093-000004S3
A - Stainless steel pail 9 liters	DV093-000009S3
A - Stainless steel pail 16 liters	DV093-000016S3
B - Drum transfer tool (only) 3/4"	BR010-000012XX
B - Drum transfer tool 3/4" kit	BR010-000012KT

4" high heater belt, 120 volts, 1200 watts, with easy adjustable thermostat control. The temperature can be adjusted between 50 °F and 425 °F (10 °C and 218 °C).

D - HEAVY DUTY METAL DRUM HEATER BELT	CODE
34 and 40 gal drum	BR301-003440XX
45 and 55 gal drum	BR301-004555XX



STAINLESS STEEL DRUM FILLER TANK	CODE
58 gal (69 USG) 2' x 3' x 20" outlet 1" MPT	EM157-020320S3
Aluminum base	EM357-263840A1
Stainless steel lid	EM357-010203S3



BRIX EQUALIZER TANK (INSULATED) 250 GAL	CODE
Complete including: one insulated SS tank 250 gal with complete Brix balancer mixer, one frame ss with wheels for Brix tank, one aluminium ladder, one in-line refractometer 0-80 Brix assy, one pumping unit diaphragm electric 1/2"	EM165-000250KT
(Kit) including: one insulated SS tank 250 gal with complete Brix balancer mixer, one in-line refractometer 0-80 Brix assy, one pumping unit diaphragm electric 1/2"	EM165-010250KT

OPTION BRIX EQUALIZER TANK	CODE
Option frame w/o wheel & ladder	EM265-020400KT
Option wheels (4) for frame	EM265-050000KT

BRIX READER	CODE
0-80 Brix assembly mounted on bracket & ready to be installed on equipment	DV176-000080KT



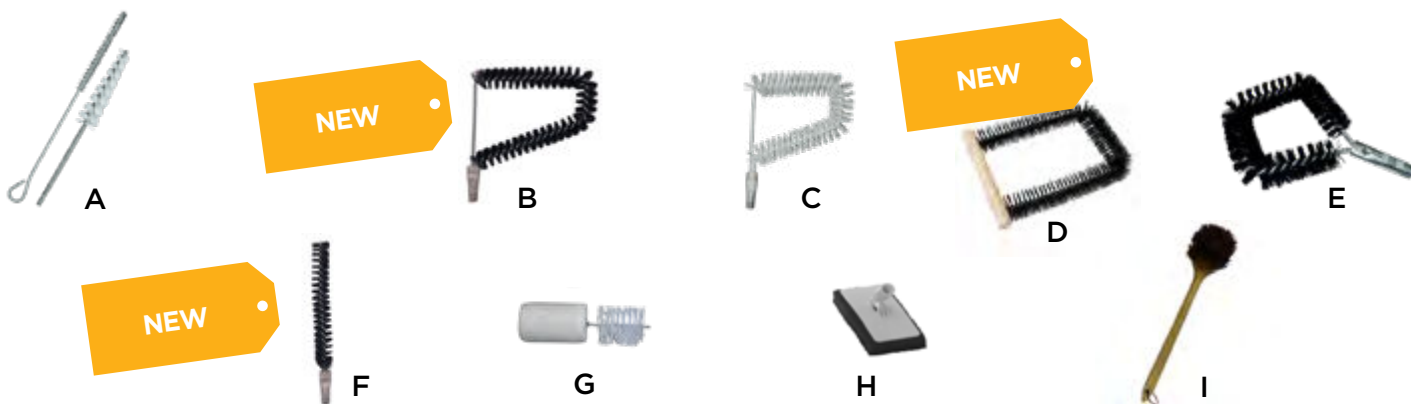

CLEANING ACCESSORIES	CODE
A - 5/16" spout brush	DV073-000005XX
A - 7/16" spout brush	DV073-000007XX
B - Exterior flue brush 9" x 1 1/2" black nylon	DV075-000924XX
C - White nylon flue brush 7" x 2"	DV075-000732XX
C - White nylon flue brush 9" x 2"	DV075-000932XX
D - Black Nylon flue brush 1 1/16 (U)	DV074-001116XX

CLEANING ACCESSORIES	CODE
E - Brush - tube pan 7" diameter	DV076-000002XX
F - Brush for rounded pipe flue pan 10" x 1 1/2"	DV077-001022XX
Brush for Turbo 3 pipe 9" model	AO103-000002ST
Extension for brush on turbo 3 pipe 9"	AO103-000001ST
Complete assembly of the brush for 9" Turbo 3 pipe	AO003-000001ST
G - 1" mainline brush (pack/24)	DV080-010016XX
G - 1 1/4" mainline brush (pack/12)	DV080-010020XX
G - 1 1/2" mainline brush (pack/12)	DV080-010024XX
G - 2" mainline brush (pack/10)	DV080-010032XX
H - Base only for 9" blue removable cotton cloth	DV085-000009XX
I - 20" hand brush for evaporator	DV072-000020XX



PAN AND TUBING CLEANERS	CODE
Super Clean 85% 4 L	DV430-000004XX
Super Clean 85% 20 L	DV430-000020XX
Pan-O-Net 4 L	DV431-000004XX
Myster pan 85% 4 L	DV630-850004XX
Myster pan 85% 20 L	DV630-850020XX

FOOD GRADE ISOPROPYL ALCOHOL 70% (CANADA ONLY)
4 L (1 gal)
20 L (5 gal)
205 L (45 gal)

Sani-Marc's 70% isopropyl alcohol (IPA) is ready to use, it is approved by the CFIA (Canadian Food Inspection Agency) to be used for the sanitization of sap tubing systems. Follow the recommended method published by Center Acer.

(Available for Canadian customers only).

For more information, please refer to your Lapierre representative.



STAINLESS STEEL CLEANER	CODE
400 ml	DV494-000400XX

CHLORINE	CODE
20 L	DV421-000020XX



INDIANA

Harris Sugar Bush

Arthur and Rebecca Harris
999 East County Road 325 North
Greencastle, IN 46135
Phone: 765 653-5108
Cell.: 765 301-0016
aharris@joink.com
www.harrissugarbush.com

MAINE

Suga Country Products

Joe and Adele Suga
871 Cross Hill Road
Vassalboro, ME 04989
Phone: 207 923-3355
Cell.: 207 592-7351
sugacountryproducts@gmail.com
www.sugacountryproducts.com

Bacon Farm Maple Products

Shelley & Kevin Bacon
1427 Pond Rd.
Sidney, Me 04330
Sugarhouse: 207 547-5053
Cell.: 207 314-8289
shelley@baconfarmmaple.com
www.baconfarmmaple.com

MASSACHUSETTS

Hickory Hill Farm

Paul Sena
159 Buffington Hill Road
P.O. Box 272
Worthington, MA 01098
Phone: 413 238-5514
Cell.: 413 896-2720
hickoryhillmaple@gmail.com
www.worthingtonballooning.com

MICHIGAN

Great Lakes Maple Supply

Dale Forester
5785 Gamble Road
Atlanta, MI 49709
Phone: 269 625-6738
Phone: 269 503-0259
info@greatlakesmaplesupply.com
www.greatlakesmaplesupply.com

Mazurek Maple Supplies

Loren, Lisa and Lynn Mazurek
5056 N. Clark Rd.
Woodland, MI 48897
Phone: 616 755-3626 (store)
mazurekmaple@gmail.com

NEW HAMPSHIRE

Bascom's Maple Farms Inc.

Bruce Bascom
56 Sugar House Road
Alstead, NH 03602
Phone: 603 835-6361
Fax: 603 835-2455
sales@bascommapple.com
www.bascommapple.com

Fuller's Sugarhouse

Dave Fuller
267 Main Street
Lancaster, NH 03584
Phone: 603 788-2719
Toll free: 877 788 2719
Fax: 603 788-4221
info@fullerssugarhouse.com
www.fullerssugarhouse.com

Huckins Maple Farm

Jason Huckins
200 Bean Hill RD
Northfield, NH 03276
Cell.: 603 393-7036
jasonhuckins@gmail.com

NEW YORK

Effley Falls Sugar Shanty

Kenneth Zehr
9601 Frank Kirch Road
Croghan, NY 13327
Phone: 315 771-2368
bkzehr@hughes.net

Big Tree Maple

Lloyd Munsee
2040 Holly Lane
Lakewood, NY 14750
Phone: 716 763-5917
Cell.: 716 487-7633
Fax: 716 763 3257
lmunsee@bigtreemaple.com
www.bigtreemaple.com

Shaver Hill

Dwayne Hill
450 Shaver Road
Harpersfield, NY 13786
Cell.: 607-652-6792
info@shaverhillmaple.com

Sage Family Maple LLC.

4449 Sage Rd.
Warsaw, NY 14569
Phone: 716 560-0742
hamilton@sagefamilymaple.com

Widrick Maple

Phillip and Alayne Widrick
21243 Staplin Road
Black River, NY 13612
Phone: 315 775-4964
widrickmaple@yahoo.com

Ridge Creek Farm Maple Supply

Ken Lango
3923 Piety Ridge Road
Marathon, NY 13803
Cell.: 845 243-1197
klango125@gmail.com

Devin Randall

102 Airport Access Road
Swanton, VT 05488
Phone: 802 868-2328
Cell.: 518 260-6746
devin.randall@elapierre.com

OHIO

Richards Maple Products

7955 Euclid Chardon Rd
Kirtland, Ohio, 44094
Phone: 330 206-1606
fred@richardsmapleproducts.com

Stumpwater Farm LLC.

Al & Jared Baxter
29499, Clark Road
Sullivan, OH 44880
Phone: 419 736-3576
Cell.: 419 606-2213
Cell.: 440 935-2318 (Jared)
stumpwater@outlook.com

PENNSYLVANIA

Brookfield Maple Products

Bud Bowers
111 Plank Road
Westfield, PA 16950
Phone: 814 367-5284
Cell.: 570 439-0969
bbowerslsg@gmail.com



Frost Ridge Maple Farm

Pat & Michele Mihailov & Dylan Stigerwalt
14611 Dickson Street
Guys Mills, PA 16327
Phone: 814 337-2483
Cell.: 814 720-9656
Cell.: 814 795-9294
frostridge@zoominternet.net
www.frostridgemaplefarm.com

Loch's Maple

Randy and Jamie Loch
143 Cokely Road
Springville, PA 18844
Phone: 570 965-2679
maple4u@epix.net
www.lochsmapple.com

VERMONT

Goodrich's Maple Farm

2427 US Route 2
Cabot, VT 05647
Phone: 800 639-1854
Fax: 802 426-3388
goodrichsmapple@yahoo.com
ricky.maple@yahoo.com

Emerson Sugarhouse

Mike Emerson
2040 Snake Road
Newbury, VT 05051
Phone: 802 429-2100
Cell.: 802 356-4914
emersonsugarhouse@fairpoint.net

Maple Brothers

Kevin Heiden
138 Quarry Road
Perkinsville, VT 05151
Phone: 802 263-9487
Phone: 802 384-8312
kheiden@tds.net

Corse Maple Farm

Roy Corse
773 Corse Road
Whitingham, VT 05361
Phone: 802 368-2420
corsemapplefarm@myfairpoint.net
www.corsemapplefarm.com

Kevin Spaulding

102 Airport Access Road
Swanton, VT 05488
Bureau: 802 868-2328
Cell.: 802 370-0925
kevin.spaulding@elapierre.com

Whites Maple Equipment

Charlie & Ryan White
695 Danby Pawlet Road
Danby, VT 05739
Phone: 802 293-5409
Phone: 802 293-5609
whitesmapleequipment@gmail.com

Mount Pleasant Sugarworks

Donna & Andy Hutchison
2668, US Route 7
Leicester, VT 05733
Phone: 802 247-3117
Toll Free: 800 439-3117
mtpleasantmaple@gmail.com

**Brassard Sugarworks
and Maple Supply LLC**

Dan Brassard
849 VT RT 14 N
East Randolph, VT 0504
Phone: 802 839-9939
brassardsugarworks@gmail.com

Ronnie Sheltra

102 Airport Access Road
Swanton, VT 05488
Phone: 802 868-2328
Cell.: 802 370-4892
ronnie.sheltra@elapierre.com

WISCONSIN

Midwest Maple Supply

Whitney Rinehart
N2611 Rinehart Drive
Athens, WI 54411
Phone: 715 560-2222
midwestmaple@gmail.com

Maple Hollow

Joe Polak
W1887 Robinson Drive
Merrill, WI 54452
Phone: 715 536-7251
info.maplehollow@frontier.com
www.maplehollowsyrup.com

Sippl's Sugarbush

Andy Sippl
N12020 Tamrack Road
Birnamwood, WI 54414
Phone: 715 449-3426
Cell.: 715 216-4627
sipplssugarbush@hotmail.com
www.sipplssugarbush.com

QUÉBEC

CHAUDIÈRE / APPALACHES

Services Acéricoles AB Inc.

Alexandre Baillargeon
201-1, route 204
Ste-Justine, QC G0R 1Y0
Cell. : 418 625-0528
servicesacericolesab@outlook.com

Marcel Morissette (Point de vente)

171, boulevard Bégin,
Ste-Claire, QC G0R 2V0
418 883-3388
nmorissette@mmorissette.net

Distribution MBD inc.

Michael Dubé
304, rue Principale
Ste-Perpétue-de-L'Islet, QC
G0R 3Z0
Cell. : 418 234-3750
entretiendube@elapierre.com

**Quincaillerie Champagne
(Point de vente)**

Marika Demers
417, 9^e rang
St-Honoré, QC G0M 1V0
Tél. : 418 485-6459
marika@quincailleriechampagne.ca

Dany-Pierre Laliberté

669, 4e Rang-Ouest,
St-Nérée, QC G0R 3V0
Cell.: 418 805-5606
dany-lapierre.laliberte@elapierre.com

Lapierre St-Jacques-de-Leeds

105, rue Industrielle
St-Jacques-de-Leeds, QC G0N 1J0
Tél. : 418 424-3030
mstjacques@elapierre.com

ST-ULBADE ET ENVIRONS

Quincaillerie BMR Pierre Naud Inc.

Félix Lemay
464, rue St-Paul
St-Ubalde, QC GOA 4L0
Tél. : 418 277-2225
Cell.: 418 336-2413
f.lemay@pierrenaud.com



RIVE-NORD

Installation Picaouette Inc.
Régis Caouette
8121, route Arthur-Sauvé
Mirabel, QC J7N 2R6
Tél.: 450 258-3888
Télé.: 450 258-1185
Cell.: 514 703-1688 (Régis)
Cell.: 514 208-0255 (Catherine)
picaouetteinc@hotmail.com

Synerbrix inc.
Mathieu Roy et Karen Ferland
851, route Gagné
St-Justin, QC J0K 2V0
Cell.: 819 698-8426
mathieu.roy@elapierre.com

ESTRIE / CENTRE-DU-QUÉBEC

Équip. d'Érablière Verville Inc.
Pierre et Stéphane Verville
466, avenue Pie-X
St-Christophe-d'Arthabaska,
QC G6R 0M9
Tél.: 819 357-4322
Cell.: 819 352-2998 (Pierre)
Cell.: 819 352-1595 (Stéphane)
info@eeverville.com

Équipements Érablière RC Inc.
Rémi Castonguay
2905 route Principale
St-Édouard-de-Lotbinière
QC G0S 1Y0
Tél.: 581 446-2705
Cell.: 418 575-8269
remi_castonguay@hotmail.com

Centre de Rénovation de l'Anse Inc.
118, route 170
L'Anse-Saint-Jean, QC GOV 1J0
Tél.: 418 272-2411
dave.gagne@homehardware.ca

Distribution Acernois S.E.N.C.
William Noiseux
47 rue St-Joseph
Granby, QC J2G 6T5
Cell.: 450 204-9102
acernois@hotmail.com

Equipements Acériques CM Inc.
Charles Lachance
130, 5e avenue Sud
St-Gédéon-de-Beauce, QC G0M 1T0
Cell.: 418 225-6595
info@equipementsacm.com

OUEST DU QUÉBEC

Francois Benny
212, rang St-Charles
Havelock, QC J0S 2C0
Cell.: 514 796-3358
f.benny@hotmail.com

BAS-SAINT-LAURENT / CÔTE SUD

Forêtmax
Succursale Pohénégamook
Julien Chouinard
1415, route 289 (Principale)
Pohénégamook, QC GOL 1J0
Tél.: 418 859-3030
Cell.: 418 860-7882
julien.foretmax@gmail.com

Forêtmax
Succursale Squatec
Yoann Belisle et Robert Lévesque
139A, rue St-Joseph
Squatec, QC GOL 4H0
Tél.: 418 855-1049 (Magasin)
Cell.: 418 551-6443 (Yoann)
Cell.: 418 551-4761 (Robert)
amenagementforetmax@bellnet.ca
foretmaxyoann@bellnet.ca
foretmaxrobert@outlook.fr

ABITIBI-TÉMISCAMINGUE

Danny Girard
156, rue Lafort
Témiscaming, QC JOZ 3R0
Tél.: 819 627-7028
Cell.: 819 627-6041
dannygirard81@hotmail.com

NOUVEAU-BRUNSWICK

Rocky Mountain Maple
David Briggs
2979, Main Street
Hillsborough, NB E4H 2X9
Tél.: 506 382-3380
Cell.: 506 866-5946
dsbriggs@nbnet.nb.ca

Lapierre St-Quentin
Maxime Lord et Daniel Savard
167, route 260
St-Quentin, NB E8A 2L5
Tél.: 506 235-2793
Cell.: 506 760-0088 (Maxime)
Cell.: 506 253-1536 (Daniel)
Fax: 506 235-2792
maxime.lord@elapierre.com

NOUVELLE-ÉCOSSE

Kevin McCormick Sales and Service
Kevin McCormick
789 Rodney Road
Springhill, NS B0M 1X0
Cell.: 902 694-0145 (Kevin)
Cell.: 902 694-5943 (Brad)
kevinmccormick@seasidehighspeed.com

ONTARIO

**Springdale Farm Maple
Equipment and Supplies**
Stephen Dodds
1790 Galbraith Road RR2
Clayton, ON K0A 1P0
Tél.: 613 256-4045
Cell.: 613 250-0493
info@springdalemaple.ca
www.springdalemaple.ca

**Weber Sugarbush Supplies Inc.
Waterloo Wellington
et Southwestern Ontario**
Harvey Weber
2844 Lobsinger Line
Heidelberg, ON N0B 2M0
Tél.: 519 699-4769

**Squirrel Creek Farm Ltd
Central Ontario**
Steven, Rachael & Christopher
275 Brackenridge Drive
RR2 Millbrook, ON LOA 1G0
Tél.: 705 932-2868
Cell.: 705 872-7629 (Steven)
steven@squirrelcreek.ca
rachael@squirrelcreek.ca
maple@squirrelcreek.ca
www.squirrelcreek.ca

**Reist Farm Supplies Inc.
Waterloo Wellington
et Southwestern Ontario**
Edgar and Edwin
6681 Line 86 RR2
Elmira, ON N3B 2Z2
Tél.: 519 669-1422

Garland Sugar Shack
Ivan et Jocelyne Garland
5930 Garlandside Road
Vars, ON K4B 1S9
Tél.: 613 835-3362
Cell.: 613 327-3050
garlandssugarshack@gmail.com

**Maple Ridge Farm
Manitoulin and North Shore /
St. Joseph Island**
Brian Bainborough
228 Smith Bay Road
Gore Bay On POP 1H0
Cell.: 705 229-9345
Fax: 705 797-8427

Agent is based in our stores

LES ÉQUIPEMENTS LAPIERRE INC.

(head office)
99, rue de l'Escale
Saint-Ludger, Beauce, QC
G0M 1W0
1 833 548-5454
Phone: 819 548-5454
Fax: 819 548-5460
info@elapierre.com

MANUFACTURING/SERVICE

DISTRIBUTION CENTER

LAPIERRE-WATERLOO-SMALL

201, rue Western
Waterloo, QC
J0E 2N0
Phone: 450 539-3663
Fax: 450 539-2660
info.lws@elapierre.com

MANUFACTURING/SERVICE

DISTRIBUTION CENTER

LAPIERRE USA SWANTON

102 Airport Access Road
Swanton, VT
05488
Phone: 802 868-2328
Fax: 802 868-9281
info.usa@elapierre.com

SERVICE

DISTRIBUTION CENTER

LAPIERRE ST-QUENTIN

167, Route 260
St-Quentin, NB
E8A 2L5
Phone: 506 235-2793
Fax: 506 235-2792
maxime.lord@elapierre.com

DISTRIBUTION CENTER

LAPIERRE SAINT-JACQUES-DE-LEEDS

105, rue Industrielle
Saint-Jacques-de-Leeds
G0N 1J0
Phone: 418 424-3030
Fax: 418 424-3000
mstjacques@elapierre.com

DISTRIBUTION CENTER

LAPIERRE ST-GEORGES

9455, boulevard Lacroix
Saint-Georges, QC
G5Y 2B6
Phone: 581 825-1300
magasin.stg@elapierre.com

SERVICE

DISTRIBUTION CENTER



Your sales representative



99, rue de l'Escale, Saint-Ludger, Beauce, QC G0M 1W0 CANADA
TF.: 833 548-5454 | Fax.: 819 548-5460 | info@elapierre.com | www.elapierre.com